

**SINGER**  
**22W34, W39, W40, W125, W172, W173,**  
**W206**

# LIST OF PARTS



**MACHINES**  
Nos. 22w34, 22w39,  
22w40, 22w125, 22w172,  
22w173 and 22w206

THE SINGER MANUFACTURING COMPANY

# INDEX

COPYRIGHT, U. S. A.,  
1914, 1918, 1919, 1921, 1922, 1925 AND 1927,  
BY THE SINGER MANUFACTURING COMPANY  
ALL RIGHTS RESERVED FOR ALL COUNTRIES

ACCESSORIES .....	61
BOBBIN WINDER .....	72
FEED DOGS .....	76
KNEE LIFTER .....	73
"    " .....	74
MACHINE No. 22w34 .....	7
"    " 22w59 .....	17
"    " 22w40 .....	27
"    " 22w125 .....	33
"    " 22w172 .....	40
"    " 22w173 .....	50
"    " 22w206 .....	62
MISCELLANEOUS PARTS .....	76
NEEDLE HOLDERS .....	78
NUMERICAL LIST OF PARTS .....	97
OBSOLETE PARTS .....	95
PRESSER FEET .....	79
ROLLER PRESSERS .....	82
THREAD UNWINDER .....	74
THROAT PLATES .....	87

From the library of: Diamond Needle Corp

# Instructions for Ordering

In ordering from this list, use **ONLY** the **PART** number in the **FIRST** column.

The number stamped on a Sewing Machine Part is the number of the **Single Part** only, except when the part includes Set Screws, Clamping Screws, Studs and Rollers Spun on, Small Wires riveted, or Parts soldered together, etc., which it is necessary to furnish in combination.

Every combination of parts sent out has its specific number which, although not stamped on Parts (except in above cases) must be used when ordering the combination.

Each number always indicates the **SAME PART** in whatever list it appears, or for whatever Machine.

The letters after some of the numbers indicate the style of finish only, as follows:

- A. Hardened, Polished and Plated.
- B. Polished and Plated.
- C. Hardened only.
- D. Polished only.
- E. Soft, not polished.
- F. Hardened and Polished.
- H. Blued

These letters **MUST BE USED** when they appear in the list and **AFTER** the number, as in the list.

In this series

- 200001 to 201500 are Screw Numbers.
- 201501 to 201800 are Nut Numbers.
- 201801 to 202000 are Roller Numbers.
- 202001 and upward are numbers of Machine Parts.

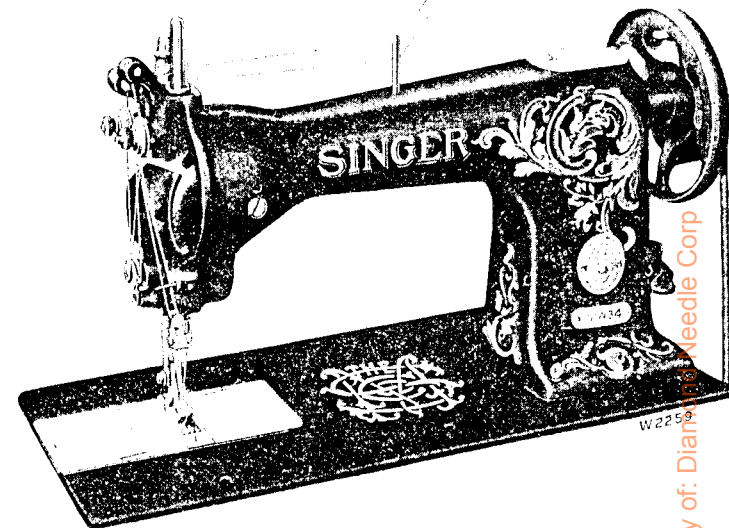
The figures in the second column refer only to the plate in which the illustration of the part is shown and are **NOT TO BE USED** in ordering.

Two or more numbers over a cut indicate that the difference between such parts is not visible in an illustration.

Parts marked with an asterisk (\*) are furnished only when repairs are made at the factory.

## LIST OF PARTS COMPLETE

FOR



### MACHINE No. 22w34

DROP FEED. ALTERNATING PRESSERS

For Shoes, Gloves, etc.

In gauges from  $\frac{1}{16}$  to  $\frac{1}{4}$  inch

No.	Plate	Name
*204471	---	Arm with 200439c, 202036 and 204705 .....
204163	12305	Arm Cap .....
200278n	12311	" " Screw .....
202248	12307	" " Washer .....
204235	11806	" Position Pin (2) .....
200963i	12311	" Screw (3) .....
202005	12308	" " Washer (3) .....
213001	11867	" Shaft .....
204705	12334	" " Bushing (front) .....
200439c	12311	" " " Position Screw ..
204440	12333	" " Connection with four 200054i (2) .....
200054i	12397	Arm Shaft Connection Screw (2) ..
202299	---	" " Oil Packing (wick) (2)

From the library of: [Dian's Needle Corp](#)

No.	Plate	Name
204805	12333	Balance Wheel, 5½ in. diam. (belt groove 2½ in. diam.), with 200328c and 200335c .....
200062H	12311	Balance Wheel Adjusting Screw ..
200328c	12311	" " Position Screw .....
200335c	12311	" " Set Screw .....
*203300	---	Bed with 202062, 203248, 203249, two each 200362c, 200516E, 200840E and 202299 .....
202258	12081	Bed Hinge Connection (2) .....
200570E	12311	" " " Screw (1) .....
203329	11871	" Slide (back) .....
203301	12334	" " (front) .....
203208	11242	Bobbin (2) .....
203210	11242	" Case Base with 202056, 203211 to 203213 and 203216 .....
203211	11284	Bobbin Case Base Latch .....
*202056	---	" " " " Pin .....
203212	11284	" " " " Plunger ..
203213	11284	" " " " Spring .....
203209	11242	" " Cap with 200984c, 203214, 203215 and two 200594c ..
203214	11284	Bobbin Case Tension Spring .....
200984c	11284	" " " " Regu- lating Screw .....
200594c	11284	Bobbin Case Tension Spring Screw
203215	11284	" " Thread Guide .....
200594c	11284	" " " " Screw ..
203216	-	" " Washer (cloth) .....
203217	11284	Bobbin Case complete, Nos. 203209 and 203210 .....
213746	11901	Face Plate with 200366H, 202087, 204730, two each 200368H, 202099, 204281 and three 200397H .....
200053c	12311	Face Plate Screw .....
204730	12386	" " Thread Guide .....
200397H	12309	" " " " Set Screw
213747	11901	Face Plate complete, Nos. 200577H, 202088, 203766, 204280, 213746, two each 200309I, 204059 and 204272
203303	12334	Feed Bar with 204189 .....
203309	---	" " 203303 with 200214c, 201525E and 204200 .....
200214E	12386	Feed Bar Hinge Screw .....
201525E	12386	" " " " Nut .....
214424	12386	" " Spring .....
204189	12306	" " Hook .....
211650	11874	" Dog, for 212112 .....
211298	14317	" " " 212134 .....
212571	14317	" " " 212569 .....

No.	Plate	Name
236411	14318	Feed Dog, for 211070 .....
236419	14318	" " " 211073 .....
211674	11874	" " " 212271 .....
211679	14315	" " " 212272 .....
214685	14315	" " " 212273 .....
236423	14318	" " " 212088 .....
212474	14318	" " " 211193 .....
212169	14318	" " " 211196 .....
200196E	12311	" " Screw (2) .....
200075E	12079	" " Support Screw .....
201535E	12079	" " " " Nut .....
203233	12305	" Driving Cam with 200382c and 200437c .....
204192	12081	Feed Driving Cam Fork Lever with 204195 and 204293 .....
204193	11897	Feed Driving Cam Fork Lever Connection with 200668c and 201525E .....
204194	12306	Feed Driving Cam Fork Lever Connection Clamp with 200031c ..
200031E	12311	Feed Driving Cam Fork Lever Connection Clamp Pinch Screw ..
200668c	12386	Feed Driving Cam Fork Lever Connection Clamp Screw Stud ..
201525E	12386	Feed Driving Cam Fork Lever Connection Clamp Screw Stud Nut .....
200002E	12338	Feed Driving Cam Fork Lever Connection Hinge Screw .....
201522E	12338	Feed Driving Cam Fork Lever Connection Hinge Screw Nut ..
*204195	---	Feed Driving Cam Fork Lever Shaft .....
204197	12306	Feed Driving Cam Fork Lever Shaft Collar with 200113E .....
200113E	12225	Feed Driving Cam Fork Lever Shaft Collar Set Screw .....
204293	12308	Feed Driving Cam Fork Lever Shaft Position Pin .....
204196	11897	Feed Driving Cam Fork Lever Shaft Sleeve (split) .....
200043c	12311	Feed Driving Cam Fork Lever Shaft Sleeve Set Screw .....
201524E	12338	Feed Driving Cam Fork Lever Shaft Sleeve Set Screw Nut .....
204198	12334	Feed Driving Cam Fork Lever complete, Nos. 204192 and 204194 ..
200437c	12311	Feed Driving Cam Position Screw
200382c	11897	" " " Set Screw .....
204199	12333	" " Rock Shaft .....

No.	Plate	Name
206554	----	Feed Driving Rock Shaft 204199 with 200002E, 201522E and 204193
202305	11897	Feed Driving Rock Shaft Center (2)
200043c	12311	" " " " " Set Screw (2) .....
204200	12305	Feed Driving Rock Shaft Crank with 204189 (on left side) and two 200383c .....
200383c	12311	Feed Driving Rock Shaft Crank Set Screw .....
213007	12079	Feed Lifting Cam with 202126 ....
204202	12308	" " " Fork with 200027c
200027E	12338	" " " " Pinch Screw
202126	12308	" " " Position Pin ...
200045E	12338	" " " Screw .....
203305	12334	" " Rock Shaft .....
203315	12334	" " " " 203305 with 203238 .....
202305	11897	Feed Lifting Rock Shaft Center (2)
200043c	12311	" " " " " Set Screw (2) .....
202276	12308	Feed Lifting Rock Shaft Slide Block
203238	12308	" " " " " " " 202276 with 200243E and 201531E
200243E	12338	Feed Lifting Rock Shaft Slide Block Hinge Screw .....
201531E	12308	Feed Lifting Rock Shaft Slide Block Hinge Screw Nut .....
204206	12306	Feed Regulating Handle .....
204207	12334	" " " " 204206 with 200098E, 202622, 204208 to 204210, 204213 and 204925 .....
204208	12307	Feed Regulating Handle Adjustable Stop .....
200098E	12307	Feed Regulating Handle Adjustable Stop Screw .....
204925	12306	Feed Regulating Handle Adjustable Stop Screw Washer .....
204209	12307	Feed Regulating Handle Position Pin .....
204210	12306	Feed Regulating Handle Shaft ...
204211	12306	" " " " Crank with 200098E .....
204212	12307	Feed Regulating Handle Shaft Crank Link .....
200271E	12311	Feed Regulating Handle Shaft Crank Link Hinge Screw (lower)
200291E	12307	Feed Regulating Handle Shaft Crank Link Hinge Screw (upper)

No.	Plate	Name
200098E	12307	Feed Regulating Handle Shaft Crank Set Screw .....
204213	12307	Feed Regulating Handle Shaft Sleeve (split) .....
200362c	12311	Feed Regulating Handle Shaft Sleeve Set Screw .....
207622	12306	Feed Regulating Handle Shaft Sleeve Washer .....
202036	12338	Feed Regulating Handle Stop Pin
204214	--	Feed Regulating Handle complete, Nos. 200291E, 204207, 204211 and 204212 .....
*203463	----	Hook (sewing) .....
203464	11242	" 203463 with 201253c, 201376E and 203251 .....
203465	----	Hook and Bobbin Case complete, Nos. 203217 and 203464 .....
203241	11007	Hook Bevel Gear Socket, 24 teeth
200555H	11097	" " " " Screw ...
203242	11007	" " Pinion, 24 teeth, with two 200383c (2) .....
200383c	12311	Hook Bevel Pinion Set Screw ....
203306	12333	" Counter Shaft .....
203244	12308	" " " Collar with two 200393c .....
200393c	11007	Hook Counter Shaft Collar Set Screw .....
203245	11007	Hook Counter Shaft Driving Gear, 44 teeth, with 200362c and 200439c
213157	11144	Hook Counter Shaft Driving Gear 203245 with 200945E and 213007
200439c	12311	Hook Counter Shaft Driving Gear Position Screw .....
200362c	12311	Hook Counter Shaft Driving Gear Set Screw .....
203246	11007	Hook Counter Shaft Gear, 22 teeth, with two 200383c .....
200383c	12311	Hook Counter Shaft Gear Set Screw
202299	----	" " " Oil Packing (wick) .....
200840E	11007	Hook Counter Shaft Oil Packing (wick) Stop Screw .....
203247	12333	Hook Driving Shaft .....
203248	12081	" " " Bearing with 202299 .....
202299	----	Hook Driving Shaft Bearing Oil Packing (wick) .....
202126	12308	Hook Driving Shaft Bearing Posi- tion Pin .....

## Parts for Machine No. 22w34

No.	Plate	Name
200516E	12311	Hook Driving Shaft Bearing Screw
203249	11007	" " " Bushing (cecen trle) .....
202299	-----	Hook Driving Shaft Bushing Oil Packing (wick) .....
200362C	12311	Hook Driving Shaft Bushing Set Screw .....
213141	11897	Hook Driving Shaft Collar with two 200393C .....
200393C	11007	Hook Driving Shaft Collar Set Screw .....
203251	11284	Hook Gib .....
201376F	11897	" " Hinge Screw .....
201253F	12079	" " Screw .....
203307	11242	" Saddle (left or right) with 202299 .....
202299	-----	Hook Saddle Oil Packing (wick) ..
200006E	11007	" " Screw (4) .....
225585	11007	" " Washer (4) .....
203718	11242	" Washer .....
203468	11242	Hook Saddle (left or right) com- plete, Nos. 200555U, 203241, 203307, 203465 and 203718 .....
203469	-----	Hook Saddle Combination (left and right) complete, Nos. two 203468
208490	12081	Knee Lifter Connection Lever .....
227311	-----	" " " " 208490 with 227302, 227308 and two 200262U .....
200262U	12306	Knee Lifter Connection Lever Hinge Screw .....
227308	12081	Knee Lifter Connection Lever Lift- ing Rod with 202302 .....
202302	12306	Knee Lifter Connection Lever Lift- ing Rod Cotter Pin .....
227302	12081	Knee Lifter Lifting Lever .....
200262U	12306	" " " " Hinge Screw .....
204475	10483	Lifting Lever with 200122U .....
208389	-----	" " 204475 with 200935U, 201534E, 204478 and 206659 .....
213004	12079	Lifting Lever Driving Crank .....
204478	10483	" " " " Link
200122U	10483	" " " " "
200400C	11897	Stop Screw .....
200387C	11897	Lifting Lever Driving Crank Posi- tion Screw .....
		Lifting Lever Driving Crank Posi- tion Screw Set Screw .....

No.	Plate	Name
204479	11897	Lifting Lever Driving Crank Posi- tion Set Screw Packing (brass)
200181D	10483	Lifting Lever Stop Screw .....
204480	10483	" " Stud Lifting Bracket with 200086C and 200181D .....
208390	-----	Lifting Lever Stud Lifting Bracket 204480 with 208389 .....
200086C	12308	Lifting Lever Stud Lifting Bracket Pinch Screw .....
206658	11837	Lifting Presser Foot, 46 needle hole, needles $\frac{3}{16}$ in. apart, in gauges $\frac{1}{16}$ , $\frac{3}{16}$ and $\frac{1}{2}$ in. for 206678
229641	14066	Lifting Presser Foot, 46 needle hole, in gauges $\frac{1}{16}$ , $\frac{1}{8}$ and $\frac{3}{16}$ in. for 206671 .....
229642	14066	Lifting Presser Foot, 46 needle hole, in gauges $\frac{1}{16}$ and $\frac{1}{8}$ in. for 206661 .....
229650	14067	Lifting Presser Foot, 46 needle hole, in gauges $\frac{1}{16}$ , $\frac{1}{8}$ , $\frac{3}{16}$ and $\frac{1}{2}$ in. for 229651 .....
229652	14067	Lifting Presser Foot, 46 needle hole, in gauges from $\frac{1}{16}$ to $\frac{1}{2}$ in. in steps of $\frac{1}{16}$ in. for 229653 .....
229654	14315	Lifting Presser Foot, 46 needle hole, in gauges $\frac{1}{16}$ , $\frac{1}{8}$ , $\frac{3}{16}$ and $\frac{1}{2}$ in. for 229655 .....
200074F	12308	Lifting Presser Foot Screw .....
231390	11871	Needle Bar (hollow) .....
204418	-----	" " Connecting Link .....
204249	12308	" " " Stud with 200072C and 202277 .....
202277	-----	Needle Bar Connecting Stud Oil Packing (wick) .....
200072C	12308	Needle Bar Connecting Stud Pinch Screw .....
204326	12338	Needle Bar Packing Cord (2) .....
200504E	11897	" " Screw Bushing (lower)
200503B	11897	" " " " (upper)
231388	11832	" Holder, needles $\frac{3}{16}$ in. apart and must be set diagonally, in gauges $\frac{1}{16}$ , $\frac{3}{16}$ and $\frac{1}{2}$ in. with 201030F and two 200141F .....
231383	11832	Needle Holder, in gauges from $\frac{1}{16}$ to $\frac{1}{2}$ in. in steps of $\frac{1}{16}$ in. with 201030F and two 200141F .....
231385	11832	Needle Holder, in gauges from $\frac{1}{16}$ to $\frac{3}{8}$ in. in steps of $\frac{1}{16}$ in. with 201030F and two 200141F .....

No.	Plate	Name
201030f	11897	Needle Holder Screw .....
200141f	11897	" Set Screw .....
204251	12334	Presser Bar (hollow) with 200074f
204252	12308	" " Lifter .....
200550c	12311	" " " Hinge Screw ...
204254	12307	" " Lifting Bracket Posi- tion Guide .....
200362c	12311	Presser Bar Lifting Bracket Posi- tion Guide Set Screw .....
204327	12306	Presser Bar Packing Washer (felt)
200504e	11897	" " Screw Bushing (lower)
204482	12079	" " Spring .....
200491b	12305	" " Thumb Screw (pres- sure regulating) .....
201506b	12376	Presser Bar Thumb Screw Check Nut .....
213008	11144	Take-up Cam with 200347c, 200383c, 200387c, 200400c, 200430c and 204479 .....
203172	12307	Take-up Cam Friction Washer ...
200430c	12311	" " Position Screw .....
200383c	12311	" " " " Check Screw .....
200347c	12376	Take-up Cam Set Screw .....
213923	11144	Take up Cam complete, Nos. 204418, 213004 and 213008 .....
203311	13104	Take-up Lever .....
221454	---	" " 203311 with 204263...
204263	12386	" " Bearing with 204264
204264	12306	" " " Position Pin...
200042f	12311	" " " Screw .....
201816	12307	" " Roller .....
203312	13104	Take-up Lever complete, Nos. 200042f, 201816 and 221454 .....
202402	12309	Tension Disc .....
202090	12309	" " Position Pin .....
203766	12079	" Release Lever .....
200309e	10483	" " " Screw .....
202075	12309	" " Plunger .....
206530	13104	" " Slide .....
206608	13104	" " " Spring .....
202407	10881	" Spring .....
200632b	12309	" Stud .....
200397h	12309	" " Set Screw .....
201572b	10881	" Thumb Nut .....
204271	12309	" Washer .....
204272	12309	Tension complete, Nos. 200632b, 201572b, 202075, 202407, 204271 and two 202402 .....

No.	Plate	Name
204274	12309	Thread Controller Plate .....
200577h	12311	" " " Screw ....
202098	12309	" " Roller .....
204275	12309	" " " Guard .....
202084	12309	" " " Washer
200300c	12309	" " " Screw .....
204276	12309	" " Spring .....
204333	12309	" " " Guard .....
200581h	12309	" " " Screw...
202087	12079	" " " Stop .....
202088	12079	" " " Stud with 204925 .....
200366h	12309	Thread Controller Spring Stud Set Screw .....
204925	12306	Thread Controller Spring Stud Washer .....
205987	12309	Thread Controller complete, Nos. 200300c, 200581h, 202084, 202098, 204274, 204275 and 204333 .....
204280	12309	Thread Controller and Spring com- plete, Nos. 204276 and 205987 ....
203313	12386	Thread Guide .....
204556	12386	" " .....
204281	12309	" Retainer Guide Wire .....
202091	12309	" " Sleeve .....
202092	12309	" " Spring .....
204058	12309	" " Stud .....
200368h	12309	" " " Set Screw .....
204059	12309	Thread Retainer complete, Nos. 202091, 202092 and 204058 .....
212112	14323	Throat Plate, 50 needle hole, need- les $\frac{1}{16}$ in. apart, for needle sizes 14 and 15, in gauges $\frac{1}{16}$ , $\frac{3}{16}$ and $\frac{1}{4}$ in., for 211650 .....
212134	14320	Throat Plate, 50 needle hole, for needle sizes 14 and 15, in gauges $\frac{1}{16}$ , $\frac{1}{8}$ and $\frac{3}{16}$ in., for 211298 .....
212569	11825	Throat Plate, 50 needle hole, for needle sizes 14 and 15, in gauges $\frac{1}{16}$ and $\frac{1}{8}$ in., for 212571 .....
211070	11824	Throat Plate, 50 needle hole, for needle sizes 14 and 15, in gauges $\frac{1}{16}$ and $\frac{3}{16}$ in., for 236411 .....
211073	11824	Throat Plate, 50 needle hole, for needle sizes 14 and 15, in $\frac{1}{16}$ in. gauge, for 236419 .....
212088	11824	Throat Plate, 50 needle hole, for needle sizes 14 and 15, in gauges $\frac{1}{16}$ and $\frac{1}{8}$ in., for 236423 .....



No.	Plate	Name
211193	11824	Throat Plate, 50 needle hole, for needle sizes 14 and 15, in gauges $\frac{11}{16}$ and $\frac{5}{8}$ in., for 212471 .....
211196	11824	Throat Plate, 50 needle hole, for needle sizes 14 and 15, in gauges $\frac{11}{16}$ and $\frac{5}{8}$ in., for 212469 .....
212271	14320	Throat Plate, 50 needle hole, for needle sizes 14 and 15, in gauges $\frac{11}{16}$ , $\frac{5}{8}$ and $\frac{3}{4}$ in., for 211671 .....
212272	14320	Throat Plate, 50 needle hole, for needle sizes 14 and 15, in gauges $\frac{5}{8}$ , $\frac{3}{4}$ and $\frac{11}{16}$ in., for 211679 .....
212273	14323	Throat Plate, 50 needle hole, for needle sizes 14 and 15, in gauges $\frac{5}{8}$ and $\frac{3}{4}$ in., for 211685 .....
200161b	12319	Throat Plate Clamp Screw .....
202062	12308	" " Position Pin .....
200577b	12311	" " Screw .....
206660	-----	Vibrating Presser Bar .....
206659	12376	" " " 206660 with 204493 and two 200138b .....
200935e	12079	Vibrating Presser Bar Hinge Screw .....
201534e	12225	" " " " " " " " Nut .....
229838	12376	Vibrating Presser Bar Position Stop .....
200053c	12311	" " " " " " " " Screw .....
204493	-----	Vibrating Presser Bar Spring .....
200138b	12079	" " " " " " Screw .....
206678	11839	" " " " Foot, for 206658 .....
206671	11839	" " " " " 229641 .....
206661	11839	" " " " " 229642 .....
229651	14067	" " " " " 229650 .....
229653	14067	" " " " in gauges from $\frac{11}{16}$ to $\frac{5}{8}$ in., in steps of $\frac{1}{16}$ in., for 229652 .....
229655	14315	Vibrating Presser Foot, in gauges $\frac{11}{16}$ , $\frac{5}{8}$ , $\frac{3}{4}$ and $\frac{7}{8}$ in., for 229654 .....
200098e	12307	Vibrating Presser Foot Screw .....
203357	12079	" " " " Washer .....

**LIST OF PARTS COMPLETE**  
FOR  
**MACHINE No. 22w39**

DROP FEED. ROLLER PRESSER  
For Stitching and Trimming Leather or Gloves  
In gauges from  $\frac{11}{16}$  to  $\frac{5}{8}$  inch

No.	Plate	Name
*204441	-----	Arm with 200439c, 202036 and 204351 .....
215948	12081	Arm Bracket .....
290189n	11140	" " Screw (3) .....
246075	12081	" " Switch Handle with 204481, 201528n and 201842 .....
215951	12079	Arm Bracket Switch Handle Spring .....
200161n	12319	" " " " " " Screw .....
200859e	11140	Arm Bracket Switch Handle Stud .....
204346	11140	" " " " " " Bushing .....
201528n	12079	Arm Bracket Switch Handle Stud Nut .....
204347	11140	Arm Bracket Switch Handle Stud Spring .....
204443	12080	Arm Bracket Switch Spring .....
204349	12080	" " " " Hook .....
208491	---	Arm Bracket complete, Nos. 200161n, 200391c, 200859e, 201528n, 204346, 204347, 204448, 215948, 215951, 215953 and 246075 .....
204163	12305	Arm Cap .....
200278n	12311	" " Screw .....
202248	12307	" " " Washer .....
204235	11806	" Position Pin (2) .....
200963e	12311	" Screw (3) .....
202005	12308	" " Washer (3) .....
203202	12333	" Shaft .....
204351	12081	" " Bushing (front) .....
200439c	12311	" " " Position Screw .....
204440	12333	" " Connection with four 200054e (2) .....
200054e	12307	Arm Shaft Connection Screw .....

From the library of: Diamond Needle Corp

No.	Plate	Name
204805	12333	Balance Wheel, 5½ in. diam. (belt groove 2¾ in. diam.), with 200328c and 200335c .....
200062u	12311	Balance Wheel Adjusting Screw ..
200328c	12311	" " Position Screw ....
200335c	12311	" " Set Screw .....
*203300	-----	Bed with 202062, 203248, 203249, two each 200362c, 200516E, 200810E and 202299 .....
202258	12081	Bed Hinge Connection (2) .....
200570E	12311	" " " Screw (4) ....
203329	11871	" " Slide (back) .....
203301	12334	" " (front) .....
203470	11249	Bobbin (2) .....
*203498	-----	" Case .....
203648	11284	" " Latch .....
*202056	-----	" " " Pin .....
203473	11284	" " " Plunger .....
203474	11284	" " " Spring .....
203499	11249	" " Lever .....
*203476	-----	" " " Eccentric .....
204243	11284	" " " " Position Pin .....
203506	11249	" " " Fulcrum .....
200056E	10884	" " " " Screw ....
203478	11249	" " " Slide Stud .....
203214	11284	" " Tension Spring .....
200984c	11284	" " " " Regulat- ing Screw .....
200594c	11284	Bobbin Case Tension Spring Screw
203216	-----	" " Washer (cloth) ....
203500	11249	Bobbin Case complete, Nos. 200594c, 200984c, 202056, 203214, 203216, 203473, 203474, 203498 and 203648
204533	12333	Face Plate with 200366u, 204730, two each 200368u, 202090, 204281 and three 200397u .....
200053c	12311	Face Plate Screw .....
204730	12386	" " Thread Guide .....
200397u	12309	" " " " Set Screw
204534	-----	Face Plate complete, Nos. 200113f, 200135E, 200319c, 200577u, 204277 to 204280, 204330, 204533, 204555, two each 200309E, 204059 and 204272 .....
203303	12334	Feed Bar with 204189 .....
203309	-----	" " 203303 with 200214E, 201525E and 204200 .....
200214E	12386	Feed Bar Hinge Screw .....
201525E	12386	" " " " Nut .....
214424	12386	" " Spring .....

No.	Plate	Name
204189	12306	Feed Bar Spring Hook .....
212103	14317	" Dog, for 212197 .....
200106E	12311	" " Screw (2) .....
200075E	12079	" " Support Screw .....
201535E	12079	" " " " Nut .....
203233	12305	" Driving Cam with 200382c and 200437c .....
204192	12081	Feed Driving Cam Fork Lever with 204195 and 204293 .....
204193	11897	Feed Driving Cam Fork Lever Connection with 200668c and 201525E
204194	12306	Feed Driving Cam Fork Lever Connection Clamp with 200031E ..
200031E	12311	Feed Driving Cam Fork Lever Connection Clamp Pinch Screw ....
200668c	12386	Feed Driving Cam Fork Lever Connection Clamp Screw Stud .....
201525E	12386	Feed Driving Cam Fork Lever Connection Clamp Screw Stud Nut..
200002E	12338	Feed Driving Cam Fork Lever Connection Hinge Screw .....
201522E	12338	Feed Driving Cam Fork Lever Connection Hinge Screw Nut .....
*204195	-----	Feed Driving Cam Fork Lever Shaft .....
204197	12306	Feed Driving Cam Fork Lever Shaft Collar with 200113E .....
260113E	12225	Feed Driving Cam Fork Lever Shaft Collar Set Screw .....
204293	12308	Feed Driving Cam Fork Lever Shaft Position Pin .....
204196	11897	Feed Driving Cam Fork Lever Shaft Sleeve (split) .....
200043c	12311	Feed Driving Cam Fork Lever Shaft Sleeve Set Screw .....
201524E	12338	Feed Driving Cam Fork Lever Shaft Sleeve Set Screw Nut ....
204198	12334	Feed Driving Cam Fork Lever complete, Nos. 204192 and 204194 ..
200437c	12311	Feed Driving Cam Position Screw
200382c	11897	" " " Set Screw ....
204199	12333	" " Rock Shaft .....
206554	-----	" " " " 204199 with 200002E, 201522E and 204193 ....
202305	11897	Feed Driving Rock Shaft Center (2)
200043c	12311	" " " " " Set Screw (2) .....
204200	12305	Feed Driving Rock Shaft Crank with 204189 (on left side) and two 200383c .....

No.	Plate	Name
200383c	12311	Feed Driving Rock Shaft Crank Set Screw .....
213007	12079	Feed Lifting Cam with 202126 ...
204202	12308	" " " Fork with 200027E
200027E	12338	" " " Pinch Screw
202126	12308	" " " Position Pin ..
200045E	12338	" " " Screw .....
203305	12334	" " Rock Shaft .....
203315	12334	" " " " 203305 with 203238 .....
202305	11897	Feed Lifting Rock Shaft Center (2)
200043c	12311	" " " " " Set Screw (2) .....
202276	12308	Feed Lifting Rock Shaft Slide Block
203238	12308	" " " " " " 202276 with 200243E and 201531E
200243E	12338	Feed Lifting Rock Shaft Slide Block Hinge Screw .....
201531E	12308	Feed Lifting Rock Shaft Slide Block Hinge Screw Nut .....
204206	12306	Feed Regulating Handle .....
204207	12334	" " " 204206 with 200098E, 202622, 204208 to 204210, 204213 and 204925 .....
204208	12307	Feed Regulating Handle Adjustable Stop .....
200098E	12307	Feed Regulating Handle Adjustable Stop Screw .....
204925	12306	Feed Regulating Handle Adjustable Stop Screw Washer .....
204209	12307	Feed Regulating Handle Position Pin .....
204210	12306	Feed Regulating Handle Shaft ....
204211	12306	" " " " Crank with 200098E .....
204212	12307	Feed Regulating Handle Shaft Crank Link .....
200271E	12311	Feed Regulating Handle Shaft Crank Link Hinge Screw (lower)
200291E	12307	Feed Regulating Handle Shaft Crank Link Hinge Screw (upper)
200098E	12307	Feed Regulating Handle Shaft Crank Set Screw .....
204213	12307	Feed Regulating Handle Shaft Sleeve (split) .....
200362c	12311	Feed Regulating Handle Shaft Sleeve Set Screw .....
202622	12306	Feed Regulating Handle Shaft Sleeve Washer .....

No.	Plate	Name
202036	12338	Feed Regulating Handle Stop Pin
204214	---	Feed Regulating Handle complete, Nos. 200291E, 204207, 204211 and 204212 .....
*203482	---	Hook (sewing) .....
203483	11249	" 203482 with 201253E, 201376E and 203251 .....
203503	13104	Hook and Bobbin Case complete, Nos. 203483 and 203500 .....
213810	11249	Hook Bevel Gear Socket, 24 teeth...
200555H	11007	" " " " Screw ....
203242	11007	" " Pinion, 24 teeth, with two 200383c (2) .....
200383c	12311	Hook Bevel Pinion Set Screw ....
203306	12333	" Counter Shaft .....
203244	12308	" " " Collar with two 200393c .....
200393c	11007	Hook Counter Shaft Collar Set Screw .....
203245	11007	Hook Counter Shaft Driving Gear, 44 teeth, with 200362c and 200439c
213157	11144	Hook Counter Shaft Driving Gear 203245 with 200045E and 213007...
200439c	12311	Hook Counter Shaft Driving Gear Position Screw .....
200362c	12311	Hook Counter Shaft Driving Gear Set Screw .....
203246	11007	Hook Counter Shaft Gear, 22 teeth, with two 200383c .....
200383c	12311	Hook Counter Shaft Gear Set Screw
202299	---	" " " Oil Packing (wick) .....
200840E	11007	Hook Counter Shaft Oil Packing (wick) Stop Screw .....
203247	12333	Hook Driving Shaft .....
203248	12081	" " " Bearing with 202299 .....
202299	---	Hook Driving Shaft Bearing Oil Packing (wick) .....
202126	12308	Hook Driving Shaft Bearing Position Pin .....
200516E	12311	Hook Driving Shaft Bearing Screw
203249	11007	" " " Bushing (eccentric) .....
202299	---	Hook Driving Shaft Bushing Oil Packing (wick) .....
200362c	12311	Hook Driving Shaft Bushing Set Screw .....
213141	11897	Hook Driving Shaft Collar with two 200393c .....

No.	Plate	Name
200393c	11007	Hook Driving Shaft Collar Set Screw .....
203251	11284	Hook Gib .....
201376F	11897	" " Hinge Screw .....
201253F	12079	" " Screw .....
203508	11249	" Saddle (left or right) with 200056F .....
200006E	11007	Hook Saddle Screw (4) .....
202622	12306	" " " Washer (4) ...
213018	11249	" Washer with 203476 and two 204243 .....
203509	11249	Hook Saddle (left or right) complete. Nos. 200555n, 203478, 203499, 203503, 203506, 203508, 213018 and 213810 .....
203510	—	Hook Saddle Combination (left and right) complete. Nos. two 203509
208490	12081	Knee Lifter Connection Lever ....
227311	—	" " " " 208490 with 227302, 227308 and two 200262n .....
200262n	12306	Knee Lifter Connection Lever Hinge Screw .....
227308	12081	Knee Lifter Connection Lever Lifting Rod with 202302 .....
202302	12306	Knee Lifter Connection Lever Lifting Rod Cotter Pin .....
227302	12081	Knee Lifter Lifting Lever .....
200262n	12306	" " " " Hinge Screw .....
207805	12079	Knife
204447	12081	" Bar with 200094F .....
204448	—	" " 204447 with 204452 ....
215953	12081	" " Bell Crank with 200337c, 201528n, 204349 and 204449 .....
204449	12079	Knife Bar Bell Crank Bearing ....
201481c	12079	" " " " Driving Screw Stud .....
201528n	12079	Knife Bar Bell Crank Driving Screw Stud Nut .....
200391c	11140	Knife Bar Bell Crank Position Screw .....
200337c	12079	Knife Bar Bell Crank Stop Screw
201528n	12079	" " " " " " Nut .....
204370	12081	Knife Bar Driving Cam with 200347c and 200434c .....
200434c	12079	Knife Bar Driving Cam Position Screw .....

No.	Plate	Name
201808	—	Knife Bar Driving Cam Roller and Stud .....
201842	12079	Knife Bar Driving Cam Roller and Stud 201808 with 201528n .....
201528n	12079	Knife Bar Driving Cam Roller and Stud Nut .....
200347c	12376	Knife Bar Driving Cam Set Screw
204452	11140	" Holder .....
200094F	11140	" " Screw .....
200126d	11140	" Screw (2), for $\frac{1}{8}$ in. gauge block .....
203715	11874	Needle Bar (hollow) .....
204248	12307	" " Connecting Link ....
200658c	12307	" " " " Hinge Screw Stud .....
201519E	12079	Needle Bar Connecting Link Hinge Screw Stud Nut .....
201249	12308	Needle Bar Connecting Stud with 200072c and 202277 .....
202277	—	Needle Bar Connecting Stud Oil Packing (wick) .....
200072c	12308	Needle Bar Connecting Stud Pinch Screw .....
204326	12338	Needle Bar Packing Cord (2) ....
200868	11140	" " Screw Bushing (lower)
200867B	11140	" " " " (upper)
203708	11832	" Holder, needles $\frac{3}{8}$ in. apart and must be set diagonally. in gauges $\frac{1}{8}$ , $\frac{3}{16}$ and $\frac{1}{4}$ in. for trimming .035, .045 and .060 in., with two each 200141F and 200581n, for Needle Bar 203715 .....
200581n	12309	Needle Holder Screw .....
200141F	11897	" Set Screw .....
204252	12308	Presser Bar Lifter .....
200550c	12311	" " " Hinge Screw ..
204455	11140	" " Lifting Bracket with 200387c .....
204254	12307	Presser Bar Lifting Bracket Position Guide .....
200362c	12311	Presser Bar Lifting Bracket Position Guide Set Screw .....
200387c	11897	Presser Bar Lifting Bracket Set Screw .....
204327	12306	Presser Bar Packing Washer (felt)
200868	11140	" " Screw Bushing (lower)
204255	12079	" " Spring .....
200493B	11140	" " Thumb Screw (pressure regulating) .....

No.	Plate	Name
201906	11845	Roller Presser, $\frac{11}{16}$ in. diam., $\frac{3}{8}$ in. face (fine), with 200548c and 201534u .....
202839	-----	Roller Presser Arm .....
204567	11845	" " " " 202839 with 201906 .....
229341	14307	Roller Presser Arm Bracket (swing) .....
229344	---	Roller Presser Arm Bracket 229341 with 200096b, 201071b, 204567 and 229325 .....
200675c	12225	Roller Presser Arm Bracket Position Screw Stud .....
202558	12225	Roller Presser Arm Bracket Spring .....
229370	12079	" " " " " " .....
		Stop and Back Needle Guard Holder .....
229371	-----	Roller Presser Arm Bracket Spring Stop and Back Needle Guard Holder 229370 with 200350u, 201317f and 226220 .....
200350u	11845	Roller Presser Arm Bracket Spring Stop and Back Needle Guard Holder Adjusting Screw .....
200141f	11897	Roller Presser Arm Bracket Spring Stop and Back Needle Guard Holder Set Screw .....
200096b	12225	Roller Presser Arm Screw .....
204495	12225	" " Bar .....
200548c	14307	" " Hinge Screw .....
201534u	12225	" " " " Nut .....
229328	14398	" " Needle Guard (back), for gauges $\frac{3}{16}$ , $\frac{1}{4}$ , $\frac{5}{16}$ and $\frac{3}{8}$ inch .....
201317f	12079	Roller Presser Needle Guard (back) Clamp Screw .....
226220	14307	Roller Presser Needle Guard (back) Clamp Screw Washer .....
229325	11845	Roller Presser Needle Guard (front), in gauges from $\frac{3}{16}$ to $\frac{3}{8}$ in., in steps of $\frac{1}{16}$ inch .....
201071f	11845	Roller Presser Needle Guard (front) Screw .....
229345	14308	Roller Presser and Bar complete, in gauges $\frac{3}{16}$ , $\frac{1}{4}$ and $\frac{5}{16}$ in., Nos. 200675c, 202558, 204495, 229328, 229344, 229371 and two 200141f .....
213006	11144	Take-up Cam with 200335c, 200383c, 200430c, 200658c and 201519c .....

No.	Plate	Name
200430c	12311	Take-up Cam Position Screw .....
200383c	12311	" " " " Check Screw .....
200335c	12311	Take-up Cam Set Screw .....
203311	13104	" Lever .....
221454	"	" " 203311 with 204263 .....
204263	12386	" " Bearing with 204264 .....
204264	12396	" " " Position Pin .....
200042f	12311	" " " Screw .....
201816	12307	" " Roller .....
203312	13104	Take-up Lever complete, Nos. 200042f, 201816 and 221454 .....
202402	12309	Tension Disc .....
202090	12309	" " Position Pin .....
204555	12338	" Release Lever .....
200309e	10483	" " " Screw .....
202075	12309	" " Plunger .....
204456	12079	" " Slide .....
204457	12079	" " " Spring .....
202407	10881	" Spring .....
200632b	12309	" Stud .....
200397u	12309	" " Set Screw .....
201572b	10881	" Thumb Nut .....
204271	12309	" Washer .....
204272	12309	Tension complete, Nos. 200632b, 201572b, 202075, 202407, 204271 and two 202402 .....
204458	11140	Thread Controller Adjusting Collar with 200684u (for Presser Bar) .....
200684u	12398	Thread Controller Adjusting Collar Screw .....
204274	12309	Thread Controller Plate .....
200577u	12311	" " " Screw .....
202098	12309	" " Roller .....
204275	12309	" " " Guard .....
202084	12309	" " " " Washer .....
200300c	12309	" " " Screw .....
204276	12309	" " Spring .....
204333	12309	" " " Guard .....
200581u	12309	" " " " Screw .....
204277	12309	" " " Stop .....
204278	12309	" " " " Driving Gear .....
200319c	12309	Thread Controller Spring Stop Driving Gear Hinge Screw .....
200135f	12309	Thread Controller Spring Stop Screw .....
204279	12309	Thread Controller Spring Stud with 204925 .....

No.	Plate	Name
200366H	12309	Thread Controller Spring Stud Set Screw .....
204925	12306	Thread Controller Spring Stud Washer .....
205987	12309	Thread Controller complete, Nos. 200300c, 200581H, 202084, 202098, 204274, 204275 and 204333 .....
204280	12309	Thread Controller and Spring com- plete, Nos. 204276 and 205987 ..
204459	12079	Thread Guide .....
203313	12386	" " .....
204329	---	" Oiler (felt) .....
204330	12225	" " Bracket with 204329 ..
200113F	12225	" " " Screw .....
204281	12309	" Retainer Guide Wire .....
202091	12309	" " Sleeve .....
202092	12309	" " Spring .....
204058	12309	" " Stud .....
200368H	12309	" " " Set Screw .....
204059	12309	Thread Retainer complete, Nos. 202091, 202092 and 204058 .....
212197	12158	Throat Plate, 50 needle hole, nee- dles $\frac{3}{16}$ in. apart, for needle sizes 14 and 15, in gauges $\frac{1}{16}$ , $\frac{3}{16}$ and $\frac{1}{8}$ in., with 200178D, 200587D, 211416 and 211426, trims opposite the needle and .060 and .085 in. to right of seam, for 212103 .....
200161D	12319	Throat Plate Clamp Screw .....
211426	12079	" " Knife Follower .....
200587D	10483	" " " " Screw ..
211416	12079	" " " " Spring ..
200178D	12079	" " " " " ..
		Screw .....
202062	12308	Throat Plate Position Pin .....
200577H	12311	" " Screw .....

## LIST OF PARTS COMPLETE

FOR

## MACHINE No. 22w40

DROP FEED

For Stitching and Trimming Leather or Gloves

In gauges from  $\frac{1}{16}$  to  $\frac{3}{8}$  in., from  $\frac{1}{8}$  to  $\frac{1}{4}$  in. with  
Roller Presser

No.	Plate	Name
*204441	---	Arm with 200439c, 202036 and 204351 .....
215948	12081	Arm Bracket .....
200189H	11140	" " Screw (3) .....
246075	12081	" " Switch Handle with 201481c, 201528H and 201842 ..
215951	12079	Arm Bracket Switch Handle Spring
200161H	12319	" " " " " " " Screw .....
200859H	11140	Arm Bracket Switch Handle Stud
204346	11140	" " " " " " " Bushing .....
201528H	12079	Arm Bracket Switch Handle Stud Nut .....
204347	11140	Arm Bracket Switch Handle Stud Spring .....
204443	12080	Arm Bracket Switch Spring .....
204349	12080	" " " " " Hook ..
208491	---	Arm Bracket complete, Nos. 200161H, 200391c, 200859H, 201528H, 204346, 204347, 204448, 215948, 215951, 215953 and 246075 .....
204163	12305	Arm Cap .....
200278H	12311	" " Screw .....
202248	12307	" " " Washer .....
204235	11806	" Position Pin (2) .....
200963F	12311	" Screw (3) .....
202005	12308	" " Washer (3) .....
203202	12333	" Shaft .....
204351	12081	" " Bushing (front) .....
200439c	12311	" " " Position Screw ..
204440	12333	" " Connection with four 200054F (2) .....

No.	Plate	Name
200054E	12307	Arm Shaft Connection Screw . . . .
204805	12333	Balance Wheel, 5½ in. diam. (belt groove 2¾ in. diam.), with 200328c and 200335c . . . . .
200062H	12311	Balance Wheel Adjusting Screw . . .
200328c	12311	" " Position Screw . . . . .
200335c	12311	" " Set Screw . . . . .
*203300	—	Bed with 202062, 203248, 203249, two each 200362c, 200516E, 200840c and 202299 . . . . .
202258	12081	Bed Hinge Connection (2) . . . . .
200570E	12311	" " " Screw (4) . . . . .
203329	11871	" Slide (back) . . . . .
203301	12334	" " (front) . . . . .
203470	11249	Bobbin (2) . . . . .
*203498	—	" Case . . . . .
203648	11284	" " Latch . . . . .
*202056	—	" " " Pin . . . . .
203473	11284	" " " Plunger . . . . .
203474	11284	" " " Spring . . . . .
203499	11249	" " Lever . . . . .
*203476	—	" " " Eccentric . . . . .
204243	11284	" " " " Position Pin . . . . .
203506	11249	" " " Fulcrum . . . . .
200056E	10884	" " " " Screw . . . . .
203478	11249	" " " Slide Stud . . . . .
203214	11284	" " Tension Spring . . . . .
200984c	11284	" " " " Regulat- ing Screw . . . . .
200594c	11284	Bobbin Case Tension Spring Screw . . . . .
203216	—	" " Washer (cloth) . . . . .
203500	11249	Bobbin Case complete, Nos. 200594c, 200984c, 202056, 203214, 203216, 203473, 203474, 203498 and 203648 . . . . .
204533	12333	Face Plate with 200366H, 204730, two each 200368H, 202090, 204281 and three 200397H . . . . .
200053c	12311	Face Plate Screw . . . . .
204730	12386	" " Thread Guide . . . . .
200397H	12309	" " " " Set Screw . . . . .
204534	—	Face Plate complete, Nos. 200113F, 200135E, 200319c, 200577H, 204277 to 204280, 204330, 204533, 204555, two each 200309E, 204059 and 204272 . . . . .
203303	12334	Feed Bar with 204189 . . . . .
203309	—	" " 203303 with 200214E, 201525E and 204200 . . . . .

No.	Plate	Name
200214E	12386	Feed Bar Hinge Screw . . . . .
201525E	12386	" " " " Nut . . . . .
214424	12386	" " Spring . . . . .
204189	12306	" " " Hook . . . . .
211805	14318	" Dog, for 221459 . . . . .
222324	14315	" " " 222325 . . . . .
211809	11874	" " " 211952 . . . . .
200106E	12311	" " Screw (2) . . . . .
200075E	12079	" " Support Screw . . . . .
201535E	12079	" " " " Nut . . . . .
203233	12305	" Driving Cam with 200382c and 200437c . . . . .
204192	12081	Feed Driving Cam Fork Lever with 204195 and 204293 . . . . .
204193	11897	Feed Driving Cam Fork Lever Con- nection with 200668c and 201525E . . . . .
204194	12306	Feed Driving Cam Fork Lever Con- nection Clamp with 200031E . . . . .
200031E	12311	Feed Driving Cam Fork Lever Con- nection Clamp Pinch Screw . . . . .
200668c	12386	Feed Driving Cam Fork Lever Con- nection Clamp Screw Stud . . . . .
201525E	12386	Feed Driving Cam Fork Lever Con- nection Clamp Screw Stud Nut . . . . .
200002E	12338	Feed Driving Cam Fork Lever Con- nection Hinge Screw . . . . .
201522E	12338	Feed Driving Cam Fork Lever Con- nection Hinge Screw Nut . . . . .
*204195	—	Feed Driving Cam Fork Lever Shaft . . . . .
204197	12306	Feed Driving Cam Fork Lever Shaft Collar with 200113E . . . . .
200113E	12225	Feed Driving Cam Fork Lever Shaft Collar Set Screw . . . . .
204293	12308	Feed Driving Cam Fork Lever Shaft Position Pin . . . . .
204196	11897	Feed Driving Cam Fork Lever Shaft Sleeve (split) . . . . .
200043c	12311	Feed Driving Cam Fork Lever Shaft Sleeve Set Screw . . . . .
201524E	12338	Feed Driving Cam Fork Lever Shaft Sleeve Set Screw Nut . . . . .
204198	12334	Feed Driving Cam Fork Lever com- plete, Nos. 204192 and 204194 . . . . .
200437c	12311	Feed Driving Cam Position Screw . . . . .
200382c	11897	" " " Set Screw . . . . .
204199	12333	" " Rock Shaft . . . . .
206554	—	" " " " 204199 with 200002E, 201522E and 204193 . . . . .

No.	Plate	Name
202305	11897	Feed Driving Rock Shaft Center (2)
200043c	12311	" " " " " Set Screw (2) .....
204200	12305	Feed Driving Rock Shaft Crank with 204189 (on left side) and two 200383c .....
200383c	12311	Feed Driving Rock Shaft Crank Set Screw .....
213007	12079	Feed Lifting Cam with 202126 ....
204202	12308	" " " Fork with 200027c
200027c	12338	" " " " Pinch Screw
202126	12308	" " " Position Pin ...
200045c	12338	" " " Screw .....
203305	12334	" " Rock Shaft .....
203315	12334	" " " " 203305 with 203338 .....
202305	11897	Feed Lifting Rock Shaft Center (2)
200043c	12311	" " " " " Set Screw (2) .....
202276	12308	Feed Lifting Rock Shaft Slide Block
203238	12308	" " " " " " 202276 with 200243c and 201531c
200243c	12338	Feed Lifting Rock Shaft Slide Block Hinge Screw .....
201531c	12308	Feed Lifting Rock Shaft Slide Block Hinge Screw Nut .....
204206	12306	Feed Regulating Handle .....
204207	12334	" " " 204206 with 200098c, 202622, 204208 to 204210, 204213 and 204925 .....
204208	12307	Feed Regulating Handle Adjustable Stop .....
200098c	12307	Feed Regulating Handle Adjustable Stop Screw .....
204925	12306	Feed Regulating Handle Adjustable Stop Screw Washer .....
204209	12307	Feed Regulating Handle Position Pin .....
204210	12306	Feed Regulating Handle Shaft
204211	12306	" " " " " Crank with 200098c .....
204212	12307	Feed Regulating Handle Shaft Crank Link .....
200271c	12311	Feed Regulating Handle Shaft Crank Link Hinge Screw (lower)
200291c	12307	Feed Regulating Handle Shaft Crank Link Hinge Screw (upper)
200098c	12307	Feed Regulating Handle Shaft Crank Set Screw .....

No.	Plate	Name
204213	12307	Feed Regulating Handle Shaft Sleeve (split) .....
200362c	12311	Feed Regulating Handle Shaft Sleeve Set Screw .....
202622	12306	Feed Regulating Handle Shaft Sleeve Washer .....
202036	12338	Feed Regulating Handle Stop Pin
204214		Feed Regulating Handle complete, Nos. 200291c, 204207, 204211 and 204212 .....
203482		Hook (sewing) .....
203483	11249	" 203482 with 201253c, 201376c and 203251 .....
203503	13104	Hook and Bobbin Case complete, Nos. 203483 and 203500 .....
213810	11249	Hook Bevel Gear Socket, 24 teeth
200555d	11007	" " " " Screw ..
203242	11007	" " Pinion, 24 teeth, with two 200383c (2) .....
200383c	12311	Hook Bevel Pinion Set Screw ....
203306	12333	" Counter Shaft .....
203244	11007	" " " Collar with two 200393c .....
200393c	11007	Hook Counter Shaft Collar Set Screw .....
203245	11007	Hook Counter Shaft Driving Gear, 44 teeth, with 200362c and 200439c
213157	11144	Hook Counter Shaft Driving Gear 203245 with 200045c and 213007..
200439c	12311	Hook Counter Shaft Driving Gear Position Screw .....
200362c	12311	Hook Counter Shaft Driving Gear Set Screw .....
203246	11007	Hook Counter Shaft Gear, 22 teeth, with two 200383c .....
200383c	12311	Hook Counter Shaft Gear Set Screw .....
202299		Hook Counter Shaft Oil Packing (wick) .....
200849c	11007	Hook Counter Shaft Oil Packing (wick) Stop Screw .....
203247	12333	Hook Driving Shaft .....
203248	12081	" " " Bearing with 202299 .....
202299		Hook Driving Shaft Bearing Oil Packing (wick) .....
202126	12308	Hook Driving Shaft Bearing Posi- tion Pin .....



No.	Plate	Name
200516E	12311	Hook Driving Shaft Bearing Screw
203249	11007	" " " Bushing (eccentric) .....
202299	---	Hook Driving Shaft Bushing Oil Packing (wick) .....
200362C	12311	Hook Driving Shaft Bushing Set Screw .....
213141	11897	Hook Driving Shaft Collar with two 200393C .....
200393C	11007	Hook Driving Shaft Collar Set Screw .....
203251	11284	Hook Gib .....
201376F	11897	" " Hinge Screw .....
201253F	12079	" " Screw .....
203508	11249	" Saddle (left or right) with 200056E .....
200006E	11007	Hook Saddle Screw (4) .....
202622	12306	" " " Washer (4) ...
213018	11249	" Washer with 203476 and two 204243 .....
203509	11249	Hook Saddle (left or right) complete, Nos. 200555H, 203478, 203499, 203503, 203506, 203508, 213018 and 213810 .....
203510	---	Hook Saddle Combination (left and right) complete, Nos. two 203509
208490	12081	Knee Lifter Connection Lever ....
227311	---	" " " " 208490 with 227302, 227308 and two 200262H .....
200262H	12306	Knee Lifter Connection Lever Hinge Screw .....
227308	12081	Knee Lifter Connection Lever Lifting Rod with 202302 .....
202302	12306	Knee Lifter Connection Lever Lifting Rod Cotter Pin .....
227302	12081	Knee Lifter Lifting Lever .....
200262H	12306	" " " " Hinge Screw .....
207805	12079	Knife .....
213130	11140	" Adjusting Block, in gauges $\frac{1}{8}$ , $\frac{3}{16}$ , $\frac{1}{4}$ and $\frac{3}{8}$ inch .....
204447	12081	Knife Bar with 200094E .....
204448	---	" " 204447 with 204452 ...
215953	12081	" " Bell Crank with 200337C, 201528H, 204349 and 204449 ....
204449	12079	Knife Bar Bell Crank Bearing ....
201481C	12079	" " " " Driving Screw Stud .....

No.	Plate	Name
201528H	12079	Knife Bar Bell Crank Driving Screw Stud Nut .....
200391C	11140	Knife Bar Bell Crank Position Screw .....
200337C	12079	Knife Bar Bell Crank Stop Screw
201528H	12079	" " " " " " Nut .....
204370	12081	Knife Bar Driving Cam with 200347C and 200434E .....
200434E	12079	Knife Bar Driving Cam Position Screw .....
201808	---	Knife Bar Driving Cam Roller and Stud .....
201842	12079	Knife Bar Driving Cam Roller and Stud 201808 with 201528H .....
201528H	12079	Knife Bar Driving Cam Roller and Stud Nut .....
200347C	12376	Knife Bar Driving Cam Set Screw
204452	11140	" Holder .....
200094E	11140	" " Screw .....
200126D	11140	" Screw, for $\frac{1}{8}$ in. gauge block (2) .....
200076D	11140	Knife Screw, for $\frac{1}{8}$ and $\frac{3}{16}$ in. gauge blocks (2) .....
200056D	10884	Knife Screw, for $\frac{1}{8}$ and $\frac{3}{16}$ in. gauge blocks (2) .....
203715	11871	Needle Bar (hollow) .....
231390	11871	" " " " .....
201248	12307	" " Connecting Link .....
206658C	12307	" " " " Hinge Screw Stud .....
201519C	12079	Needle Bar Connecting Link Hinge Screw Stud Nut .....
204249	12308	Needle Bar Connecting Stud with 200072C and 202277 .....
202277	---	Needle Bar Connecting Stud Oil Packing (wick) .....
200072C	12308	Needle Bar Connecting Stud Pinch Screw .....
204326	12338	Needle Bar Packing Cord (2) ....
200868	11140	" " Screw Bushing (lower)
200867B	11140	" " " " (upper)
229966	11832	Needle Holder, in gauges from $\frac{3}{16}$ to $\frac{1}{4}$ in., in steps of $\frac{1}{16}$ in., for trimming .635, .045 and .060 in., with two each 200389C and 200581H, for Needle Bar 203715 ..

No.	Plate	Name
231400	14317	Needle Holder, in gauges from $\frac{1}{16}$ to $\frac{3}{8}$ in., in steps of $\frac{1}{16}$ in., for trimming .045, .060 and .085 in., with 201030F and two 200389c, for Needle Bar 231390 .....
200581u	12309	Needle Holder Screw .....
201030F	11897	" " " .....
200141F	11897	" Set Screw .....
200389c	11832	" " " .....
204251	12334	Presser Bar (hollow) with 200074F .....
204252	12308	" " Lifter .....
200550c	12311	" " " Hinge Screw ...
204455	11140	" " Lifting Bracket with 200387c .....
204254	12307	Presser Bar Lifting Bracket Position Guide .....
200362c	12311	Presser Bar Lifting Bracket Position Guide Set Screw .....
200387c	11897	Presser Bar Lifting Bracket Set Screw .....
204327	12306	Presser Bar Packing Washer (felt)
200868	11140	" " Screw Bushing (lower)
204255	12079	" " Spring .....
200493B	11140	" " Thumb Screw (pressure regulating) .....
229122	14316	Presser Foot, 46 needle hole, in gauges from $\frac{1}{16}$ to $\frac{1}{4}$ in., in steps of $\frac{1}{16}$ inch .....
229124	14316	Presser Foot, 46 needle hole, in gauges from $\frac{1}{16}$ to $\frac{1}{4}$ in., in steps of $\frac{1}{16}$ inch .....
200074F	12308	Presser Foot Screw .....
201906	11845	Roller Presser, $\frac{1}{4}$ in. diam., $\frac{1}{4}$ in. face (fine), with 200548c and 201534u .....
202839	----	Roller Presser Arm .....
204567	11845	" " " 202839 with 201906 .....
229341	14307	Roller Presser Arm Bracket (swing) .....
200675c	12225	Roller Presser Arm Bracket Position Screw Stud .....
202558	12225	Roller Presser Arm Bracket Spring
229370	----	" " " " "
		Stop and Back Needle Guard Holder .....
229371	----	Roller Presser Arm Bracket Spring Stop and Back Needle Guard Holder 229370 with 200350u, 201317F and 226220 .....

No.	Plate	Name
200350u	11845	Roller Presser Arm Bracket Spring Stop and Back Needle Guard Holder Adjusting Screw .....
200141F	11897	Roller Presser Arm Bracket Spring Stop and Back Needle Guard Holder Set Screw .....
200082d	10881	Roller Presser Arm Screw, for gauges $\frac{1}{16}$ to $\frac{1}{4}$ inch .....
200077b	14307	Roller Presser Arm Screw, for gauges $\frac{1}{8}$ and $\frac{1}{4}$ inch .....
200061d	14307	Roller Presser Arm Screw, for $\frac{1}{8}$ in. gauge .....
229744	14307	Roller Presser Arm Shim, $\frac{1}{16}$ in. thick .....
229745	14307	Roller Presser Arm Shim, $\frac{1}{16}$ in. thick .....
202760	14307	Roller Presser Arm Shim, $\frac{1}{16}$ in. thick .....
204495	12225	Roller Presser Bar .....
200548c	14307	" " Hinge Screw .....
201534u	12225	" " " " " NPT .....
229330	14309	Roller Presser Needle Guard (back), in $\frac{1}{16}$ in. gauge .....
229331	14309	Roller Presser Needle Guard (back), in $\frac{1}{8}$ in. gauge .....
229332	14309	Roller Presser Needle Guard (back), in $\frac{3}{16}$ in. gauge .....
229347	14314	Roller Presser Needle Guard (back), in $\frac{1}{4}$ in. gauge, with 350061F .....
229334	14309	Roller Presser Needle Guard (back), in $\frac{1}{8}$ in. gauge, with 350061F .....
229335	14309	Roller Presser Needle Guard (back) in $\frac{1}{4}$ in. gauge, with 350061F .....
222300	----	Roller Presser Needle Guard (back), in $\frac{1}{4}$ in. gauge, with 200397u, for use when trimming .035 or .045 in. from seam .....
201317F	12079	Roller Presser Needle Guard (back) Clamp Screw .....
226220	14307	Roller Presser Needle Guard (back) Clamp Screw Washer ..
200397u	12309	Roller Presser Needle Guard (back) Screw .....
350061F	14314	Roller Presser Needle Guard (back) Screw .....

No.	Plate	Name
229346	14308	Roller Presser and Bar complete, in $\frac{3}{8}$ in. gauge, Nos. 200082b, 200675c, 202558, 204495, 204567, 229330, 229341, 229371, 229744, 229745 and two 200141e .....
229950	----	Roller Presser and Bar complete, in $\frac{3}{8}$ in. gauge, Nos. 200082b, 200675c, 202558, 202760, 204495, 204567, 229331, 229341, 229371 and two 200141e .....
229951	---	Roller Presser and Bar complete, in $\frac{3}{8}$ in. gauge, Nos. 200077b, 200675c, 202558, 202760, 204495, 204567, 229332, 229341, 229371, 229744 and two 200141e .....
229952	----	Roller Presser and Bar complete, in $\frac{3}{8}$ in. gauge, Nos. 200077b, 200675c, 202558, 202760, 204495, 204567, 229341, 229347, 229371, 229745 and two 200141e .....
229953	----	Roller Presser and Bar complete, in $\frac{3}{8}$ in. gauge, Nos. 200077b, 200675c, 202558, 202760, 204495, 204567, 229334, 229341, 229371, 229744, 229745 and two 200141e ..
229954	----	Roller Presser and Bar complete, in $\frac{1}{2}$ in. gauge, Nos. 200064b, 200675c, 202558, 204495, 204567, 229335, 229341, 229371, two each 200141e and 202760 .....
213006	11144	Take-up Cam with 200335c, 200383c, 200430c, 200658c and 201519e ..
200430c	12311	Take-up Cam Position Screw .....
200383c	12311	" " " " Check Screw .....
200335c	12311	Take-up Cam Set Screw .....
203311	13104	" Lever .....
221454	----	" " 203311 with 204263 ..
204263	12386	" " Bearing with 204264 ..
204264	12306	" " " Position Pin ..
200042e	12311	" " " Screw .....
201816	12307	" " Roller .....
203312	13104	Take-up Lever complete, Nos. 200042e, 201816 and 221454 .....
202402	12309	Tension Disc .....
202090	12309	" " Position Pin .....
204555	12338	" Release Lever .....
200309c	10483	" " " Screw .....
202075	12309	" " Plunger .....
204456	12079	" " Slide .....

No.	Plate	Name
204457	12079	Tension Release Slide Spring ....
202407	10881	" Spring .....
200632b	12309	" Stud .....
200397b	12309	" " Set Screw .....
201572b	10881	" Thumb Nut .....
204271	12309	" Washer .....
204272	12309	Tension complete, Nos. 200632b, 201572b, 202075, 202407, 204271 and two 202402 .....
204458	11140	Thread Controller Adjusting Collar with 200684b (for Presser Bar) ..
200684b	12308	Thread Controller Adjusting Collar Screw .....
204274	12309	Thread Controller Plate .....
200577b	12311	" " " Screw ....
202098	12309	" " Roller .....
204275	12309	" " " Guard .....
202084	12309	" " " Washer .....
200300c	12309	" " " Screw .....
204276	12309	" " Spring .....
204333	12309	" " " Guard .....
200581b	12309	" " " " Screw ..
204277	12309	" " " Stop .....
204278	12309	" " " " Driving Gear .....
200319c	12309	Thread Controller Spring Stop Driving Gear Hinge Screw .....
200135e	12309	Thread Controller Spring Stop Screw .....
204279	12309	Thread Controller Spring Stud with 204925 .....
200266b	12309	Thread Controller Spring Stud Set Screw .....
204925	12306	Thread Controller Spring Stud Washer .....
205987	12309	Thread Controller complete, Nos. 200300c, 200581b, 202084, 202098, 204274, 204275 and 204333 .....
204280	12309	Thread Controller and Spring complete, Nos. 204276 and 205987 ..
204459	12079	Thread Guide .....
203313	12386	" " .....
204329	-	" Oiler (felt) .....
204330	12225	" " Bracket with 204329 ..
200413e	12225	" " " Screw .....
204281	12309	" Retainer Guide Wire .....
202091	12309	" " Sleeve .....
202092	12309	" " Spring .....
204058	12309	" " Stud .....
200368b	12309	" " " Set Screw .....

No.	Plate	Name
204059	12309	Thread Retainer complete, Nos. 202091, 202092 and 204058 .....
221459	—	Throat Plate, 50 needle hole, for needle sizes 14 and 15, in $\frac{1}{4}$ in. gauge, with 200178D, 200587D, 211416 and 211426, trims opposite the needle and .060 and .085 in. to right of seam, for 211805 .....
211952	14325	Throat Plate, 50 needle hole, for needle sizes 14 and 15, in gauges from $\frac{3}{16}$ to $\frac{3}{4}$ in., in steps of $\frac{1}{32}$ in., with 200178D, 200587D, 211416 and 211426, trims opposite the needle and .060 and .085 in. to right of seam, for 211809 .....
222325	14325	Throat Plate, 50 needle hole, for needle sizes 14 and 15, in gauges $\frac{3}{8}$ , $\frac{13}{16}$ and $\frac{7}{8}$ in., with 200178D, 200587D, 211416 and 211426, trims opposite the needle and .060 and .085 in. to right of seam, for 222324 .....
200161D	12319	Throat Plate Clamp Screw .....
211426	12079	" " Knife Follower .....
200587D	10483	" " " " Screw .....
211416	12079	" " " " Spring .....
200178D	12079	" " " " " .....
		Screw .....
202062	12308	Throat Plate Position Pin .....
200577H	12311	" " Screw .....

## MACHINE No. 22w125

DROP FEED. ALTERNATING PRESSERS

For Shoes, Gloves, etc.

In gauges from  $\frac{1}{16}$  to  $\frac{3}{4}$  inch

Same as No. 22w34 with the following exceptions:

No.	Plate	Name
*204497	---	Arm with 200439c, 202036 and 204705, in place of 204471 .....
213010	11867	Arm Shaft, in place of 213001 .....
*213052	---	Bed with 202062, 203248, 203249, two each 200362c, 200516e, 200840e and 202299, in place of 203300 .....
204294	12333	Feed Driving Rock Shaft, in place of 204199 .....
206555	---	Feed Driving Rock Shaft 204294 with 200002e, 201522e and 204193, in place of 206554 .....
227312	---	Knee Lifter Connection Lever 208490 with 227303, 227308 and two 200262H, in place of 227311 .....
227303	12084	Knee Lifter Lifting Lever, in place of 227302 .....

**LIST OF PARTS COMPLETE**  
**FOR**  
**MACHINE No. 22w172**  
**COMPOUND FEED. ROLLER PRESSER**

For Stitching Leather and Gloves

In gauges from  $\frac{3}{32}$  to  $\frac{1}{4}$  inch

No.	Plate	Name
*204800	---	Arm with 202036 .....
204163	12305	" Cap .....
200278n	12311	" " Screw .....
202248	12307	" " Washer .....
204235	11896	" Position Pin (2) .....
200963e	12311	" Screw (3) .....
202005	12308	" " Washer (3) .....
213113	12084	" Shaft .....
204801	11144	" " Bushing (back) with 202260 .....
202260	---	Arm Shaft Bushing (back) Oil Packing (wick) .....
200341c	12080	Arm Shaft Bushing (back) Set Screw .....
204802	11144	Arm Shaft Bushing (front) with 202036 and 202260 .....
202260	---	Arm Shaft Bushing (front) Oil Packing (wick) .....
200502n	11896	Arm Shaft Bushing (front) Oil Packing Thumb Screw .....
202036	12338	Arm Shaft Bushing (front) Posi- tion Pin .....
200352c	12080	Arm Shaft Bushing (front) Set Screw .....
204804	14312	Arm Shaft Connection with four 200054e (2) .....
200054e	12307	Arm Shaft Connection Screw ....
204805	12333	Balance Wheel, 5 $\frac{1}{2}$ in. diam. (belt groove 2 $\frac{1}{4}$ in. diam.), with 200328c and 200335c .....
200062n	12311	Balance Wheel Adjusting Screw ..
200328c	12311	" " Position Screw .....
200335c	12311	" " Set Screw .....

No.	Plate	Name
*213119		Bed with 202062, 203248, 203249, two each 200362c, 200516e, 200849e and 202299 .....
202258	12081	Bed Hinge Connection (2) .....
200570e	12311	" " " Screw (4) ....
203329	11871	" Slide (back) .....
203301	12331	" " (front) .....
203470	11249	Bobbin (2) .....
*203520	---	" Case .....
203648	11284	" " Latch .....
*202056		" " " Pin .....
203473	11284	" " " Plunger .....
203474	11284	" " " Spring .....
203499	11249	" " Lever .....
*203476		" " " Eccentric .....
204243	11284	" " " " Position Pin .....
203506	11249	Bobbin Case Lever Fulcrum .....
200056e	10884	" " " " Screw ..
203478	11249	" " " Slide Stud ....
203214	11284	" " Tension Spring .....
200984c	11284	" " " " Regulat- ing Screw .....
200594c	11284	Bobbin Case Tension Spring Screw
203216		" " Washer (cloth) .....
203521	11251	Bobbin Case complete, Nos. 200594c, 200984c, 202056, 203214, 203216, 203473, 203474, 203520 and 203648
213118		Face Plate with 200366n, 200685e, 202087, 204185, two each 200368n, 202090, 204281 and three 200397n
200065c	12338	Face Plate Screw (2) .....
204185	12080	" " Thread Guide .....
200397n	12309	" " " " Set Screw
213676	12084	Face Plate complete, Nos. 200309n, 200577n, 202088, 204280, 213118, 223311, two each 204059 and 204272 .....
203303	12334	Feed Bar with 204189 .....
203309		" " 203303 with 200214n, 201525e and 204200 .....
200214e	12386	Feed Bar Hinge Screw .....
201525e	12386	" " " " Nut .....
214424	12386	" " Spring .....
204189	12306	" " " Hook .....
211588	11874	" Dog, 59 needle hole, for nee- dle sizes 14 and 15, in gauges $\frac{3}{32}$ $\frac{1}{8}$ and $\frac{1}{4}$ in., for 211587 .....

No.	Plate	Name
200106E	12311	Feed Dog Screw (2) .....
200075E	12079	" " Support Screw .....
201535E	12079	" " " " Nut .....
203233	12305	" Driving Cam with 200382c and 200437c .....
204192	12081	Feed Driving Cam Fork Lever with 204195 and 204293 .....
204193	11897	Feed Driving Cam Fork Lever Con- nection with 200668c and 201525e
204194	12306	Feed Driving Cam Fork Lever Con- nection Clamp with 200031E ....
200031E	12311	Feed Driving Cam Fork Lever Con- nection Clamp Pinch Screw ....
200668c	12386	Feed Driving Cam Fork Lever Con- nection Clamp Screw Stud ....
201525E	12386	Feed Driving Cam Fork Lever Con- nection Clamp Screw Stud Nut..
200002E	12338	Feed Driving Cam Fork Lever Con- nection Hinge Screw .....
201522E	12338	Feed Driving Cam Fork Lever Con- nection Hinge Screw Nut .....
*204195	---	Feed Driving Cam Fork Lever Shaft .....
204197	12306	Feed Driving Cam Fork Lever Shaft Collar with 200113E .....
200113E	12225	Feed Driving Cam Fork Lever Shaft Collar Set Screw .....
204293	12308	Feed Driving Cam Fork Lever Shaft Position Pin .....
204196	11897	Feed Driving Cam Fork Lever Shaft Sleeve (split) .....
200043c	12311	Feed Driving Cam Fork Lever Shaft Sleeve Set Screw .....
201524E	12338	Feed Driving Cam Fork Lever Shaft Sleeve Set Screw Nut ...
204198	12334	Feed Driving Cam Fork Lever com- plete. Nos. 204192 and 204194 ..
200437c	12311	Feed Driving Cam Position Screw
200382c	11897	" " " " Set Screw ....
204821	11867	" " Rock Shaft .....
213931	---	" " " " 204821 with 200002E, 201522E and 204193 ...
202305	11897	Feed Driving Rock Shaft Center (2)
200043c	12311	" " " " " " Set Screw (2) .....
204200	12305	Feed Driving Rock Shaft Crank with 204189 (on left side) and two 200383c .....
200383c	12311	Feed Driving Rock Shaft Crank Set Screw .....

No.	Plate	Name
213007	12079	Feed Lifting Cam with 202126 ....
204202	12308	" " " Fork with 200027E
200027E	12338	" " " " Pinch Screw
202126	12308	" " " Position Pin ....
200045E	12338	" " " Screw .....
203305	12334	" " Rock Shaft .....
203315	12334	" " " " 203305 with 203238 .....
202305	11897	Feed Lifting Rock Shaft Center (2)
200043c	12311	" " " " " " Set Screw (2) .....
202276	12308	Feed Lifting Rock Shaft Slide Block
203238	12308	" " " " " " " 202276 with 200243E and 201531E
200243E	12338	Feed Lifting Rock Shaft Slide Block Hinge Screw .....
201531E	12308	Feed Lifting Rock Shaft Slide Block Hinge Screw Nut .....
204206	12306	Feed Regulating Handle .....
204288	11871	" " " 204206 with 200098E, 202622, 204208, 204209, 204213, 204289 and 204925 .....
204208	12307	Feed Regulating Handle Adjustable Stop .....
200098E	12307	Feed Regulating Handle Adjustable Stop Screw .....
204925	12306	Feed Regulating Handle Adjustable Stop Screw Washer .....
204209	12307	Feed Regulating Handle Position Pin .....
204289	11806	Feed Regulating Handle Shaft
204211	12306	" " " " " Crank with 200098E .....
204212	12307	Feed Regulating Handle Shaft Crank Link .....
200271E	12311	Feed Regulating Handle Shaft Crank Link Hinge Screw (lower)
200291E	12307	Feed Regulating Handle Shaft Crank Link Hinge Screw (upper)
200098E	12307	Feed Regulating Handle Shaft Crank Set Screw .....
204213	12307	Feed Regulating Handle Shaft Sleeve (split) .....
200362c	12311	Feed Regulating Handle Shaft Sleeve Set Screw .....
202622	12306	Feed Regulating Handle Shaft Sleeve Washer .....
202036	12338	Feed Regulating Handle Stop Pin

No.	Plate	Name
204298	----	Feed Regulating Handle complete, Nos. 200291e, 204211, 204212 and 204288 .....
*203482	----	Hook (sewing) .....
203483	11249	" 203482 with 201253e, 201376e and 203251 .....
203547	----	Hook and Bobbin Case complete, Nos. 203483 and 203521 .....
213810	11249	Hook Bevel Gear Socket, 24 teeth
200555h	11007	" " " " Screw ...
203242	11007	" " Pinion, 24 teeth, with two 200383c (2) .....
200383c	12311	Hook Bevel Pinion Set Screw ....
203306	12333	" Counter Shaft .....
203244	12308	" " " Collar with two 200393c .....
200393c	11007	Hook Counter Shaft Collar Set Screw .....
203245	11007	Hook Counter Shaft Driving Gear, 44 teeth, with 200362c and 200439c
213157	11144	Hook Counter Shaft Driving Gear 203245 with 200045e and 213007...
200439c	12311	Hook Counter Shaft Driving Gear Position Screw .....
200362c	12311	Hook Counter Shaft Driving Gear Set Screw .....
203246	11007	Hook Counter Shaft Gear, 22 teeth, with two 200383c .....
200383c	12311	Hook Counter Shaft Gear Set Screw .....
202299	----	Hook Counter Shaft Oil Packing (wick) .....
200840e	11007	Hook Counter Shaft Oil Packing (wick) Stop Screw .....
213116	12084	Hook Driving Shaft .....
203248	12081	" " " Bearing with 202299 .....
202299	----	Hook Driving Shaft Bearing Oil Packing (wick) .....
202126	12308	Hook Driving Shaft Bearing Position Pin .....
200516e	12311	Hook Driving Shaft Bearing Screw
203249	11007	" " " Bushing (eccentric) .....
202299	----	Hook Driving Shaft Bushing Oil Packing (wick) .....
200362c	12311	Hook Driving Shaft Bushing Set Screw .....
213141	11897	Hook Driving Shaft Collar with two 200393c .....

No.	Plate	Name
200393c	11007	Hook Driving Shaft Collar Set Screw .....
203251	11284	Hook Gib .....
201376e	11897	" " Hinge Screw .....
201253e	12079	" " Screw .....
203508	11249	" Saddle (left or right) with 200056e .....
200006e	11007	Hook Saddle Screw (1) .....
202622	12306	" " " Washer (4) ...
213018	11249	" Washer with 203476 and two 204243 .....
203548	11251	Hook Saddle (left or right) complete, Nos. 200555h, 203478, 203499, 203506, 203508, 203547, 213018 and 213810 .....
203597	----	Hook Saddle Combination (left and right) complete, Nos. two 203548
208490	12081	Knee Lifter Connection Lever ....
227313	----	" " " " 208490 with 227303, 227309 and two 200262h .....
200262h	12306	Knee Lifter Connection Lever Hinge Screw .....
227309	14312	Knee Lifter Connection Lever Lifting Rod with 202302 .....
202302	12306	Knee Lifter Connection Lever Lifting Rod Cotter Pin .....
227303	12084	Knee Lifter Lifting Lever .....
200262h	12306	" " " " Hinge Screw .....
231399	11871	Needle Bar (hollow) .....
213283	12080	" " Connecting Link ....
200237e	12080	" " " " Hinge Screw Stud .....
201519e	12079	Needle Bar Connecting Link Hinge Screw Stud Nut .....
201249	12308	Needle Bar Connecting Stud with 200072c and 202277 .....
202277	----	Needle Bar Connecting Stud Oil Packing (wick) .....
200072c	12308	Needle Bar Connecting Stud Pinch Screw .....
204829	11871	Needle Bar Frame .....
204830	12080	" " " Driving Crank with two 200382c .....
203154	----	Needle Bar Frame Driving Crank 204830 with 200932c, 201525e and 203155 .....
204832	11144	Needle Bar Frame Driving Crank Connection (9½ in. long) .....

No.	Plate	Name
215652	---	Needle Bar Frame Driving Crank Connection 204832 with two 201528c .....
203155	11806	Needle Bar Frame Driving Crank Connection Bearing (lower) ....
200932c	11806	Needle Bar Frame Driving Crank Connection Bearing (lower) Hinge Screw .....
201525e	12386	Needle Bar Frame Driving Crank Connection Bearing (lower) Hinge Screw Nut .....
203155	11806	Needle Bar Frame Driving Crank Connection Bearing (upper) ....
200932c	11806	Needle Bar Frame Driving Crank Connection Bearing (upper) Hinge Screw .....
201525e	12386	Needle Bar Frame Driving Crank Connection Bearing (upper) Hinge Screw Nut .....
201528c	12079	Needle Bar Frame Driving Crank Connection Bearing Check Nut ..
203114	11806	Needle Bar Frame Driving Crank Connection Bell Crank with 200387c and 200447c .....
203156	---	Needle Bar Frame Driving Crank Connection Bell Crank 203114 with two each 200932c, 201525e, and 203155 .....
200447c	11806	Needle Bar Frame Driving Crank Connection Bell Crank Position Screw .....
200387c	11897	Needle Bar Frame Driving Crank Connection Bell Crank Set Screw .....
202899	12080	Needle Bar Frame Driving Crank Connection Bell Crank Stud ....
200382c	11897	Needle Bar Frame Driving Crank Set Screw .....
204838	11144	Needle Bar Frame Pitman (7½ in. long) .....
204642	---	Needle Bar Frame Pitman 204838 with two 201528c .....
*204839	---	Needle Bar Frame Pitman Ball Bearing with 204840 and two 200086c .....
204641	12080	Needle Bar Frame Pitman Ball Bearing 204839 with 200878 ....
*204840	---	Needle Bar Frame Pitman Ball Bearing Cap .....
200086c	12308	Needle Bar Frame Pitman Ball Bearing Cap Screw .....

No.	Plate	Name
200737c	11806	Needle Bar Frame Pitman Ball Screw .....
200878	-	Needle Bar Frame Pitman Ball Screw 200737c with 201524c ....
201524c	12338	Needle Bar Frame Pitman Ball Screw Nut .....
203155	11806	Needle Bar Frame Pitman Bearing (right hand) .....
201528c	12079	Needle Bar Frame Pitman Bearing Check Nut (left or right) .....
200932c	11806	Needle Bar Frame Pitman Bearing Hinge Screw .....
201525e	12386	Needle Bar Frame Pitman Bearing Hinge Screw Nut .....
204843	12080	Needle Bar Frame Position Stud (lower) .....
200383c	12311	Needle Bar Frame Position Stud (lower) Set Screw .....
204841	11806	Needle Bar Frame Position Stud (upper) .....
200383c	12311	Needle Bar Frame Position Stud (upper) Set Screw .....
201381	11832	Needle Holder, needles ¾ in. apart and must be set diagonally, in gauges 1, 2, and 3, in., with 201030e and two 200141e .....
201030e	11897	Needle Holder Screw .....
200141e	11897	" Set Screw .....
207072	12080	Presser Bar Bushing .....
200399c	11806	" " " Set Screw ...
204252	12308	" " " Lifter .....
200550c	12311	" " " Hinge Screw ..
208609	---	" " " Lifting Bracket .....
204846	12080	" " " " 208609 with 200387c .....
204254	12307	Presser Bar Lifting Bracket Position Guide .....
200362c	12311	Presser Bar Lifting Bracket Position Guide Set Screw .....
200387c	11897	Presser Bar Lifting Bracket Set Screw .....
204258	12386	Presser Bar Spring (heavy) .....
200494b	14314	" " " Thumb Screw (pressure regulating) .....
201906	11845	Roller Presser, 1½ in. diam., ⅝ in. face (fine), with 200548c and 201534n .....
202839	-	Roller Presser Arm .....
204567	11845	" " " 202839 with 201906 .....





**LIST OF PARTS COMPLETE**  
FOR  
**MACHINE No. 22w173**

**COMPOUND FEED. ROLLER PRESSER**

For Stitching Leather and Gloves

In gauges from  $\frac{3}{16}$  to  $\frac{1}{2}$  inch

No.	Plate	Name
*204800	----	Arm with 202036 .....
204163	12305	" Cap .....
200278H	12311	" " Screw .....
202248	12307	" " Washer .....
204235	11806	" Position Pin (2) .....
200963E	12311	" Screw (3) .....
202005	12308	" " Washer (3) .....
213113	12084	" Shaft .....
204801	11144	" " Bushing (back) with 202260 .....
202260	----	Arm Shaft Bushing (back) Oil Packing (wick) .....
200341C	12080	Arm Shaft Bushing (back) Set Screw .....
204802	11144	Arm Shaft Bushing (front) with 202036 and 202260 .....
202260	----	Arm Shaft Bushing (front) Oil Packing (wick) .....
200502B	11806	Arm Shaft Bushing (front) Oil Packing Thumb Screw .....
202036	12338	Arm Shaft Bushing (front) Posi- tion Pin .....
200352C	12080	Arm Shaft Bushing (front) Set Screw .....
204804	14312	Arm Shaft Connection with four 200054E (2) .....
200054E	12307	Arm Shaft Connection Screw .....
204805	12333	Balance Wheel, 5 $\frac{1}{2}$ in. diam. (belt groove 2 $\frac{3}{4}$ in. diam.), with 200328C and 200335C .....
200062H	12311	Balance Wheel Adjusting Screw .....
200328C	12311	" " Position Screw .....
200335C	12311	" " Set Screw .....

No.	Plate	Name
*213119	---	Bed with 202062, 203248, 203249, two each 200362C, 200516E, 200840E and 202299 .....
202258	12081	Bed Hinge Connection (2) .....
200570E	12311	" " " Screw (4) .....
203329	11871	" Slide (back) .....
203301	12334	" " (front) .....
203470	11249	Bobbin (2) .....
*203520	----	" Case .....
203648	11284	" " Latch .....
*202056	----	" " " Pin .....
203473	11284	" " " Plunger .....
203474	11284	" " " Spring .....
203499	11249	" " Lever .....
*203476	----	" " " Eccentric .....
204243	11284	" " " " Position Pin .....
203506	11249	" " " Fulcrum .....
200356E	10884	" " " " Screw .....
203478	11219	" " " Slide Stud .....
203214	11284	" " Tension Spring .....
200984C	11284	" " " " Regulat- ing Screw .....
200594C	11284	Bobbin Case Tension Spring Screw .....
203216	----	" " Washer (cloth) .....
203521	11251	Bobbin Case complete, Nos. 200594C, 200984C, 202056, 203214, 203216, 203473, 203474, 203520 and 203648 .....
213118	---	Face Plate with 200366H, 200685C, 202087, 204185, two each 200368H, 202090, 204281 and three 200397H .....
200065C	12338	Face Plate Screw (2) .....
204185	12080	" " Thread Guide .....
200397H	12309	" " " " Set Screw .....
213676	12084	Face Plate complete, Nos. 200309C, 200577H, 202088, 204280, 213118, 223311, two each 204059 and 204272 .....
203303	12334	Feed Bar with 204189 .....
203309	----	" " 203303 with 200214E, 201525E and 204200 .....
200214E	12386	Feed Bar Hinge Screw .....
201525E	12386	" " " " Nut .....
214424	12386	" " Spring .....
204189	12306	" " " Hook .....
211590	12078	" Dog, 50 needle hole, for needle sizes 14 and 15, in gauges from $\frac{3}{16}$ to $\frac{1}{2}$ in., in steps of $\frac{1}{16}$ in., for 211589 .....

No.	Plate	Name
200106F	12311	Feed Dog Screw (2) .....
200075E	12079	" " Support Screw .....
201535E	12079	" " " " Nut .....
203233	12305	" Driving Cam with 200382c and 200437c .....
204192	12081	Feed Driving Cam Fork Lever with 204195 and 204293 .....
204193	11897	Feed Driving Cam Fork Lever Con- nection with 200668c and 201525e
204194	12306	Feed Driving Cam Fork Lever Con- nection Clamp with 200031F ....
200031F	12311	Feed Driving Cam Fork Lever Con- nection Clamp Pinch Screw ....
200668c	12386	Feed Driving Cam Fork Lever Con- nection Clamp Screw Stud .....
201525E	12386	Feed Driving Cam Fork Lever Con- nection Clamp Screw Stud Nut ..
200002E	12338	Feed Driving Cam Fork Lever Con- nection Hinge Screw .....
201522E	12338	Feed Driving Cam Fork Lever Con- nection Hinge Screw Nut .....
*204195	---	Feed Driving Cam Fork Lever Shaft .....
204197	12306	Feed Driving Cam Fork Lever Shaft Collar with 200113E .....
200113E	12225	Feed Driving Cam Fork Lever Shaft Collar Set Screw .....
204293	12308	Feed Driving Cam Fork Lever Shaft Position Pin .....
204196	11897	Feed Driving Cam Fork Lever Shaft Sleeve (split) .....
200043c	12311	Feed Driving Cam Fork Lever Shaft Sleeve Set Screw .....
201524E	12338	Feed Driving Cam Fork Lever Shaft Sleeve Set Screw Nut ....
204198	12334	Feed Driving Cam Fork Lever com- plete, Nos. 204192 and 204194 ...
200437c	12311	Feed Driving Cam Position Screw
200382c	11897	" " " " Set Screw ....
204821	11867	" " Rock Shaft .....
213931	---	" " " " 204821 with 200002E, 201522E and 204193 ....
202305	11897	Feed Driving Rock Shaft Center (2)
200043c	12311	" " " " " " Set Screw (2) .....
204209	12305	Feed Driving Rock Shaft Crank with 204189 (on left side) and two 200383c .....
200383c	12311	Feed Driving Rock Shaft Crank Set Screw .....

No.	Plate	Name
213007	12079	Feed Lifting Cam with 202126 ....
204202	12308	" " " " Fork with 200027E
200027E	12338	" " " " Pinch Screw
202126	12308	" " " " Position Pin ....
200045E	12338	" " " " Screw .....
203305	12334	" " Rock Shaft .....
203315	12334	" " " " 203305 with 203238 .....
202305	11897	Feed Lifting Rock Shaft Center (2)
200043c	12311	" " " " " " Set Screw (2) .....
202276	12308	Feed Lifting Rock Shaft Slide Block .....
203238	12308	Feed Lifting Rock Shaft Slide Block 202276 with 200243E and 201531E .....
200243E	12338	Feed Lifting Rock Shaft Slide Block Hinge Screw .....
201531E	12308	Feed Lifting Rock Shaft Slide Block Hinge Screw Nut .....
204206	12306	Feed Regulating Handle .....
204288	11871	" " " " 204206 with 200098F, 202622, 204208, 204209, 204213, 204289 and 204925 .....
204208	12307	Feed Regulating Handle Adjustable Stop .....
200098F	12307	Feed Regulating Handle Adjustable Stop Screw .....
204925	12306	Feed Regulating Handle Adjustable Stop Screw Washer .....
204209	12307	Feed Regulating Handle Position Pin .....
204289	11806	Feed Regulating Handle Shaft
204211	12306	" " " "
		Crank with 200098E .....
204212	12307	Feed Regulating Handle Shaft Crank Link .....
200271E	12311	Feed Regulating Handle Shaft Crank Link Hinge Screw (lower)
200291E	12307	Feed Regulating Handle Shaft Crank Link Hinge Screw (upper)
200098E	12307	Feed Regulating Handle Shaft Crank Set Screw .....
204213	12307	Feed Regulating Handle Shaft Sleeve (split) .....
200362c	12311	Feed Regulating Handle Shaft Sleeve Set Screw .....
202622	12306	Feed Regulating Handle Shaft Sleeve Washer .....

No.	Plate	Name
202036	12338	Feed Regulating Handle Stop Pin
204298	---	Feed Regulating Handle complete, Nos. 200291e, 204211, 204212 and 204288 .....
*203482	---	Hook (sewing) .....
203483	11249	" 203482 with 201253e, 201376e and 203251 .....
203547	---	Hook and Bobbin Case complete, Nos. 203483 and 203521 .....
213810	11249	Hook Bevel Gear Socket .....
200555h	11007	" " " Screw ...
203242	11007	" " Pinion, 24 teeth, with two 200383c (2) .....
200383c	12311	Hook Bevel Pinion Set Screw ....
203306	12333	" Counter Shaft .....
203244	12308	" " " Collar with two 200393c .....
200393c	11007	Hook Counter Shaft Collar Set Screw .....
203245	11007	Hook Counter Shaft Driving Gear, 44 teeth, with 200362c and 200439c
213157	11144	Hook Counter Shaft Driving Gear 203245 with 200045e and 213007..
200439c	12311	Hook Counter Shaft Driving Gear Position Screw .....
200362c	12311	Hook Counter Shaft Driving Gear Set Screw .....
203246	11007	Hook Counter Shaft Gear, 22 teeth, with two 200383c .....
200383c	12311	Hook Counter Shaft Gear Set Screw
202299	---	" " " Oil Packing (wick) .....
200840e	11007	Hook Counter Shaft Oil Packing (wick) Stop Screw .....
213116	12084	Hook Driving Shaft .....
203248	12081	" " " Bearing with 202299 .....
202299	---	Hook Driving Shaft Bearing Oil Packing (wick) .....
202126	12308	Hook Driving Shaft Bearing Posi- tion Pin .....
200516e	12311	Hook Driving Shaft Bearing Screw
203249	11007	" " " Bushing (eccen- tric) .....
202299	---	Hook Driving Shaft Bushing Oil Packing (wick) .....
200362c	12311	Hook Driving Shaft Bushing Set Screw .....
213141	11897	Hook Driving Shaft Collar with two 200393c .....

No.	Plate	Name
200393c	11007	Hook Driving Shaft Collar Set Screw .....
203251	11281	Hook Gib .....
201376e	11897	" " Hinge Screw .....
201253e	12079	" " Screw .....
203508	11249	" Saddle (left or right) with 200056e .....
200006e	11007	Hook Saddle Screw (4) .....
202622	12306	" " " Washer (4) ...
213018	11249	" Washer with 203476 and two 201243 .....
203548	11351	Hook Saddle (left or right) com- plete, Nos. 200555h, 203478, 203499, 203506, 203508, 203547, 213018 and 213810 .....
203597	---	Hook Saddle Combination (left and right) complete, Nos. two 203548
208490	12081	Knee Lifter Connection Lever ....
227313	---	" " " " 208490 with 227303, 227309 and two 200262h .....
200262h	12306	Knee Lifter Connection Lever Hinge Screw .....
227309	14312	Knee Lifter Connection Lever Lift- ing Rod with 202302 .....
202302	12306	Knee Lifter Connection Lever Lift- ing Rod Cotter Pin .....
227303	12084	Knee Lifter Lifting Lever .....
200262h	12306	" " " " Hinge Screw .....
231399	11871	Needle Bar (hollow) .....
213283	12080	" " Connecting Link ....
200237c	12080	" " " " Hinge Screw Stud .....
201519e	12079	Needle Bar Connecting Link Hinge Screw Stud Nut .....
204249	12308	Needle Bar Connecting Stud with 200072c and 202277 .....
202277	---	Needle Bar Connecting Stud Oil Packing (wick) .....
200072c	12308	Needle Bar Connecting Stud Pinch Screw .....
204829	11871	Needle Bar Frame .....
204830	12080	" " " Driving Crank with two 200382c .....
203154	---	Needle Bar Frame Driving Crank 204830 with 200932c, 201525e and 203155 .....
204832	11144	Needle Bar Frame Driving Crank Connection (9½ in. long) .....

No.	Plate	Name
215652	-----	Needle Bar Frame Driving Crank Connection 204832 with two 201528c .....
203155	11806	Needle Bar Frame Driving Crank Connection Bearing (lower) ....
200932c	11806	Needle Bar Frame Driving Crank Connection Bearing (lower) Hinge Screw .....
201525E	12386	Needle Bar Frame Driving Crank Connection Bearing (lower) Hinge Screw Nut .....
203155	11806	Needle Bar Frame Driving Crank Connection Bearing (upper) ...
200932c	11806	Needle Bar Frame Driving Crank Connection Bearing (upper) Hinge Screw .....
201525E	12386	Needle Bar Frame Driving Crank Connection Bearing (upper) Hinge Screw Nut .....
201528c	12079	Needle Bar Frame Driving Crank Connection Bearing Check Nut..
203114	11806	Needle Bar Frame Driving Crank Connection Bell Crank with 200387c and 200447c .....
203156	----	Needle Bar Frame Driving Crank Connection Bell Crank 203114 with two each 200932c, 201525E and 203155 .....
200447c	11806	Needle Bar Frame Driving Crank Connection Bell Crank Position Screw .....
200387c	11897	Needle Bar Frame Driving Crank Connection Bell Crank Set Screw
202899	12080	Needle Bar Frame Driving Crank Connection Bell Crank Stud ...
200382c	11897	Needle Bar Frame Driving Crank Set Screw .....
204838	11144	Needle Bar Frame Pitman (7½ in. long) .....
204642	----	Needle Bar Frame Pitman 204838 with two 201528c .....
*204839	----	Needle Bar Frame Pitman Ball Bearing with 204840 and two 200086c .....
204641	12080	Needle Bar Frame Pitman Ball Bearing 204839 with 200878 ....
*204840	----	Needle Bar Frame Pitman Ball Bearing Cap .....
200086c	12308	Needle Bar Frame Pitman Ball Bearing Cap Screw .....

No.	Plate	Name
200737c	11806	Needle Bar Frame Pitman Ball Screw .....
200878	----	Needle Bar Frame Pitman Ball Screw 200737c with 201524E ....
201524E	12338	Needle Bar Frame Pitman Ball Screw Nut .....
203155	11806	Needle Bar Frame Pitman Bearing (right hand) .....
201528c	12079	Needle Bar Frame Pitman Bearing Check Nut (left or right) .....
200932c	11806	Needle Bar Frame Pitman Bearing Hinge Screw .....
201525E	12386	Needle Bar Frame Pitman Bearing Hinge Screw Nut .....
204843	12080	Needle Bar Frame Position Stud (lower) .....
200383c	12311	Needle Bar Frame Position Stud (lower) Set Screw .....
204844	11806	Needle Bar Frame Position Stud (upper) .....
200383c	12311	Needle Bar Frame Position Stud (upper) Set Screw .....
231398	11832	Needle Holder, in gauges from ¾ to ¾ in., in steps of ⅛ in., with 201030E and two 200141E .....
201030E	11897	Needle Holder Screw .....
200141E	11897	" Set Screw .....
207072	12980	Presser Bar Bushing .....
200399c	11806	" " " Set Screw ....
204252	12308	" " " Lifter .....
200550c	12311	" " " Hinge Screw ...
208609	----	" " " Lifting Bracket .....
204846	12080	" " " " 208609 with 200387c .....
204254	12307	Presser Bar Lifting Bracket Position Guide .....
200362c	12311	Presser Bar Lifting Bracket Position Guide Set Screw .....
200387c	11897	Presser Bar Lifting Bracket Set Screw .....
204258	12386	Presser Bar Spring (heavy) .....
200494B	12305	" " Thumb Screw (pressure regulating) .....
201906	11845	Roller Presser, 1½ in. diam., ⅜ in. face (fine), with 200548c and 201534B .....
202839	----	Roller Presser Arm .....
204567	11845	" " " 202839 with 201906 .....

No.	Plate	Name
229341	14307	Roller Presser Arm Bracket (swing) .....
200675c	12225	Roller Presser Arm Bracket Position Screw Stud .....
202558	12225	Roller Presser Arm Bracket Spring
229370	12079	" " " " "
		Stop and Back Needle Guard Holder .....
229371	---	Roller Presser Arm Bracket Spring Stop and Back Needle Guard Holder 229370 with 200350n, 201317F and 226220 .....
200350n	11845	Roller Presser Arm Bracket Spring Stop and Back Needle Guard Holder Adjusting Screw .....
200141F	11897	Roller Presser Arm Bracket Spring Stop and Back Needle Guard Holder Set Screw .....
200382b	10881	Roller Presser Arm Screw, for gauges $\frac{3}{8}$ to $\frac{1}{2}$ inch .....
200077b	14307	Roller Presser Arm Screw, for gauges $\frac{3}{8}$ and $\frac{1}{2}$ inch .....
200064b	14307	Roller Presser Arm Screw, for gauges $\frac{1}{4}$ and $\frac{3}{8}$ inch .....
229744	14307	Roller Presser Arm Shim, $\frac{1}{16}$ in. thick .....
229745	14307	Roller Presser Arm Shim, $\frac{1}{8}$ in. thick .....
202760	14307	Roller Presser Arm Shim, $\frac{1}{8}$ in. thick .....
204495	12225	Roller Presser Bar .....
200548c	14307	" " Hinge Screw .....
201534n	12225	" " " " Nut .....
229360	---	" " Needle Guard (back), in $\frac{3}{8}$ in. gauge .....
229361	---	Roller Presser Needle Guard (back), in $\frac{1}{4}$ in. gauge .....
229349	---	Roller Presser Needle Guard (back), in $\frac{3}{8}$ in. gauge .....
229333	14309	Roller Presser Needle Guard (back), in $\frac{3}{8}$ in. gauge, with 350061F .....
229362	---	Roller Presser Needle Guard (back), in $\frac{3}{8}$ in. gauge, with 350061F .....
229363	---	Roller Presser Needle Guard (back), in $\frac{1}{4}$ in. gauge, with 350061F .....

No.	Plate	Name
229364	---	Roller Presser Needle Guard (back), in $\frac{3}{8}$ in. gauge, with 350061F .....
201317F	12079	Roller Presser Needle Guard (back) Clamp Screw .....
226220	14307	Roller Presser Needle Guard (back) Clamp Screw Washer ...
350061F	14314	Roller Presser Needle Guard (back) Screw .....
229957	---	Roller Presser and Bar complete, in $\frac{3}{8}$ in. gauge, Nos. 200082b, 200675c, 202558, 204495, 204567, 229341, 229360, 229371, 229744, 229745 and two 200141F .....
229958	---	Roller Presser and Bar complete, in $\frac{1}{4}$ in. gauge, Nos. 200082b, 200675c, 202558, 202760, 204495, 204567, 229341, 229361, 229371 and two 200141F .....
229350	---	Roller Presser and Bar complete, in $\frac{3}{8}$ in. gauge, Nos. 200082b, 200675c, 202558, 202760, 204495, 204567, 229341, 229349, 229371, 229744, 229745 and two 200141F ..
229959	---	Roller Presser and Bar complete, in $\frac{3}{8}$ in. gauge, Nos. 200077b, 200675c, 202558, 202760, 204495, 204567, 229333, 229341, 229371, 229745 and two 200141F .....
229960	---	Roller Presser and Bar complete, in $\frac{1}{4}$ in. gauge, Nos. 200077b, 200675c, 202558, 202760, 204495, 204567, 229341, 229362, 229371, 229744, 229745 and two 200141F ..
229961	---	Roller Presser and Bar complete, in $\frac{1}{4}$ in. gauge, Nos. 200064b, 200675c, 202558, 204495, 204567, 229341, 229363, 229371, two each 200141F and 202760 .....
229962	---	Roller Presser and Bar complete, in $\frac{3}{8}$ in. gauge, Nos. 200064b, 200675c, 202558, 204495, 204567, 229341, 229364, 229371, 229744, two each 200141F and 202760 .....
213011	11144	Take-up Cam with 200335c, 200383c and 200430c .....
203172	12307	Take-up Cam Friction Washer ...
200430c	12311	" " Position Screw .....
200383c	12311	" " " " Check Screw .....

No.	Plate	Name
200335c	12311	Take-up Cam Set Screw .....
213677	11144	Take-up Cam complete, Nos. 200237c, 201519e, 213011 and 213283 .....
204553	12386	Take-up Lever .....
206601	-----	" " 204553 with 204263 ..
204263	12386	" " Bearing with 204264
204264	12306	" " " Position Pin ..
200042f	12311	" " " Screw .....
201816	12307	" " Roller .....
204554	12386	Take-up Lever complete, Nos. 200042f, 201816 and 206601 .....
202402	12309	Tension Disc .....
202090	12309	" " Position Pin .....
223311	12338	" Release Lever .....
200685E	10483	" " Position Screw
200309E	10483	" " " Screw .....
202075	12309	" " Plunger .....
204848	11806	" " Slide with 203695 ....
203695	11806	" " " Spring .....
202407	10881	" Spring .....
200632B	12309	" Stud .....
200397H	12309	" " Set Screw .....
201572B	10881	" Thumb Nut .....
204271	12309	" Washer .....
204272	12309	Tension complete, Nos. 200632b, 201572b, 202075, 202407, 204271 and two 202402 .....
204274	12309	Thread Controller Plate .....
200577H	12311	" " " Screw ....
202098	12309	" " Roller .....
204275	12309	" " Guard .....
202084	12309	" " " Washer
200300c	12309	" " " Screw .....
204276	12309	" " Spring .....
204333	12309	" " " Guard .....
200581H	12309	" " " Screw ..
202087	12079	" " " Stop .....
202088	12079	" " " Stud with 204925 .....
200366H	12309	Thread Controller Spring Stud Set Screw .....
204925	12306	Thread Controller Spring Stud Washer .....
205987	12309	Thread Controller complete, Nos. 200300c, 200581H, 202084, 202098, 204274, 204275 and 204333 .....
204280	12309	Thread Controller and Spring com- plete, Nos. 204276 and 205987 ..

No.	Plate	Name
204556	12386	Thread Guide .....
203313	12386	" " .....
204281	12309	" Retainer Guide Wire .....
202091	12309	" " Sleeve .....
202092	12309	" " Spring .....
204058	12309	" " Stud .....
200368H	12309	" " " Set Screw .....
204059	12309	Thread Retainer complete, Nos. 202091, 202092 and 204058 .....
211589	12078	Throat Plate, in gauges from $\frac{3}{8}$ to $\frac{7}{8}$ in., in steps of $\frac{1}{16}$ in., for 211590
200161D	12319	Throat Plate Clamp Screw .....
202062	12308	" " Position Pin .....
200577H	12311	" " Screw .....

No.	Plate	Name
200031r	12311	Feed Driving Cam Fork Lever Connection Clamp Pinch Screw ....
200668c	12386	Feed Driving Cam Fork Lever Connection Clamp Screw Stud .....
201525e	12386	Feed Driving Cam Fork Lever Connection Clamp Screw Stud Nut ..
200002e	12338	Feed Driving Cam Fork Lever Connection Hinge Screw .....
201522e	12338	Feed Driving Cam Fork Lever Connection Hinge Screw Nut .....
*204195	---	Feed Driving Cam Fork Lever Shaft .....
204197	12306	Feed Driving Cam Fork Lever Shaft Collar with 200113r .....
200113r	12225	Feed Driving Cam Fork Lever Shaft Collar Set Screw .....
204293	12308	Feed Driving Cam Fork Lever Shaft Position Pin .....
204196	11897	Feed Driving Cam Fork Lever Shaft Sleeve (split) .....
200043c	12311	Feed Driving Cam Fork Lever Shaft Sleeve Set Screw .....
201524e	12338	Feed Driving Cam Fork Lever Shaft Sleeve Set Screw Nut ....
204198	12334	Feed Driving Cam Fork Lever complete, Nos. 204192 and 204194 ..
200437c	12311	Feed Driving Cam Position Screw
200382c	11897	" " " Set Screw ....
204294	12333	" " " Rock Shaft .....
206555	---	" " " " 204294 with 200002e, 201522e and 204193 .....
202305	11897	Feed Driving Rock Shaft Center (2)
200043c	12311	" " " " " Set Screw (2) .....
204200	12305	Feed Driving Rock Shaft Crank with 204189 (on left side) and two 200383c .....
200383c	12311	Feed Driving Rock Shaft Crank Set Screw .....
203235	14313	Feed Lifting Cam with 202126 ....
204202	12308	" " " Fork with 200027e
200027e	12338	" " " " Pinch Screw
202126	12308	" " " " Position Pin ....
200045e	12338	" " " " Screw .....
203305	12334	" " " " Rock Shaft .....
203315	12334	" " " " 203305 with 203238 .....
202305	11897	Feed Lifting Rock Shaft Center (2)
200043c	12311	" " " " " Set Screw (2) .....

No.	Plate	Name
202276	12308	Feed Lifting Rock Shaft Slide Block .....
203238	12308	Feed Lifting Rock Shaft Slide Block 202276 with 200243e and 201531e .....
200243e	12338	Feed Lifting Rock Shaft Slide Block Hinge Screw .....
201531e	12308	Feed Lifting Rock Shaft Slide Block Hinge Screw Nut .....
204206	12306	Feed Regulating Handle .....
204288	11871	" " " 204206 with 200098r, 202622, 204208, 204209, 204213, 204289 and 204925 ...
204208	12307	Feed Regulating Handle Adjustable Stop .....
200098r	12307	Feed Regulating Handle Adjustable Stop Screw .....
204925	12306	Feed Regulating Handle Adjustable Stop Screw Washer .....
204209	12307	Feed Regulating Handle Position Pin .....
204289	11806	Feed Regulating Handle Shaft
204211	12306	" " " " Crank with 200098r .....
204212	12307	Feed Regulating Handle Shaft Crank Link .....
200271e	12311	Feed Regulating Handle Shaft Crank Link Hinge Screw (lower)
200291e	12307	Feed Regulating Handle Shaft Crank Link Hinge Screw (upper)
200098r	12307	Feed Regulating Handle Shaft Crank Set Screw .....
204213	12307	Feed Regulating Handle Shaft Sleeve (split) .....
200362c	12311	Feed Regulating Handle Shaft Sleeve Set Screw .....
202622	12306	Feed Regulating Handle Shaft Sleeve Washer .....
202036	12338	Feed Regulating Handle Stop Pin
204298	---	Feed Regulating Handle complete, Nos. 200291e, 204211, 204212 and 204288 .....
*203482	---	Hook (sewing) .....
203483	11249	" 203482 with 201253e, 201376e and 203251 .....
203671	---	Hook and Robbin Case complete, Nos. 203483 and 203669 .....



No.	Plate	Name
213810	11249	Hook Bevel Gear Socket .....
200555u	11007	" " " " Screw .....
203242	11007	" " Pinion, 24 teeth, with two 200383c (2) .....
200383c	12311	Hook Bevel Pinion Set Screw .....
203306	12333	" Counter Shaft .....
203244	12308	" " " Collar with two 200393c .....
200393c	11007	Hook Counter Shaft Collar Set Screw .....
203245	11007	Hook Counter Shaft Driving Gear, 44 teeth, with 200362c and 200439c
213154	12305	Hook Counter Shaft Driving Gear 203245 with 200045c and 203235...
200439c	12311	Hook Counter Shaft Driving Gear Position Screw .....
200362c	12311	Hook Counter Shaft Driving Gear Set Screw .....
203246	11007	Hook Counter Shaft Gear, 22 teeth, with two 200383c .....
200383c	12311	Hook Counter Shaft Gear Set Screw
202299	---	" " " Oil Packing (wick) .....
200840e	11007	Hook Counter Shaft Oil Packing (wick) Stop Screw .....
213624	12333	Hook Driving Shaft .....
203248	12081	" " " Bearing with 202299 .....
202299	---	Hook Driving Shaft Bearing Oil Packing (wick) .....
202126	12308	Hook Driving Shaft Bearing Posi- tion Pin .....
200516e	12311	Hook Driving Shaft Bearing Screw
203249	11007	" " " Bushing (eccen- tric) .....
202299	---	Hook Driving Shaft Bushing Oil Packing (wick) .....
200362c	12311	Hook Driving Shaft Bushing Set Screw .....
213141	11897	Hook Driving Shaft Collar with two 200393c .....
200393	11007	Hook Driving Shaft Collar Set Screw .....
203251	11284	Hook Gib .....
201376f	11897	" " Hinge Screw .....
201253f	12079	" " Screw .....
203508	11249	" Saddle (left or right) with 200056e .....
200006e	11007	Hook Saddle Screw (4) .....
202622	12306	" " " Washer (4) ...

No.	Plate	Name
203455	---	Hook Washer with 203476 and two 204243 .....
203672	14314	Hook Saddle (left or right) com- plete, Nos. 200555u, 203455, 203478, 203499, 203506, 203508, 203671 and 213810 .....
203673	---	Hook Saddle Combination (left and right) complete, Nos. two 203672
207846	14312	Knee Lifter Connection Lever with 202446 .....
207847	---	Knee Lifter Connection Lever 207846 with 200224u, 200262u, 207849 and 227310 .....
200224u	12306	Knee Lifter Connection Lever Hinge Screw .....
227310	14312	Knee Lifter Connection Lever Lift- ing Rod with 202302 .....
202302	12306	Knee Lifter Connection Lever Lift- ing Rod Cotter Pin .....
202446	12306	Knee Lifter Connection Lever Pin
207849	12084	" " Lifting Lever .....
200262u	12306	" " " " Hinge Screw .....
204786	14313	Lifting Lever with 200122u and 204189 .....
221447	---	Lifting Lever 204786 with 200935e, 201534e, 204789 and 213021 .....
204788	11897	Lifting Lever Driving Crank .....
204789	14313	" " " " Link
200122u	10483	" " " " " Stop Screw .....
200400c	11897	Lifting Lever Driving Crank Posi- tion Screw .....
200387c	11897	Lifting Lever Driving Crank Posi- tion Screw Set Screw .....
204479	11897	Lifting Lever Driving Crank Posi- tion Screw Set Screw Packing (brass) .....
200181u	10483	Lifting Lever Stop Screw .....
204790	14313	" " Stud Lifting Bracket with 200086c and 200181u .....
221448	---	Lifting Lever Stud Lifting Bracket 204790 with 221447 .....
200086c	12308	Lifting Lever Stud Lifting Bracket Pinch Screw .....
229641	14066	Lifting Presser Foot, .46 needle hole, in gauges $\frac{1}{8}$ , $\frac{3}{16}$ , $\frac{1}{4}$ and $\frac{5}{16}$ in. for 206671 .....

No.	Plate	Name
229648	14067	Lifting Presser Foot, 46 needle hole, in gauges from $\frac{1}{4}$ to $\frac{3}{8}$ in., in steps of $\frac{1}{16}$ in., for 229649 .....
200074F	12308	Lifting Presser Foot Screw .....
231397	14312	Needle Bar (hollow) .....
231437	14313	" " Connecting Link .....
204249	12308	" " " Stud with 200072c and 202277 .....
202277	---	Needle Bar Connecting Stud Oil Packing (wick) .....
200072c	12308	Needle Bar Connecting Stud Pinch Screw .....
204326	12338	Needle Bar Packing Cord (2) .....
200504E	11897	" " Screw Bushing (lower) .....
200503B	11897	" " " " (upper) .....
231383	11832	" Holder, in gauges from $\frac{1}{4}$ to $\frac{3}{8}$ in., in steps of $\frac{1}{16}$ in., with 201030F and two 200141E .....
231385	11832	Needle Holder, in gauges from $\frac{1}{4}$ to $\frac{3}{8}$ in., in steps of $\frac{1}{16}$ in., with 201030F and two 200141E .....
201030F	11897	Needle Holder Screw .....
200141E	11897	" Set Screw .....
204718	14312	Presser Bar (hollow) with 200074E .....
204719	14313	" " Lifter .....
200550c	12311	" " " Hinge Screw .....
214097	14314	" " Lifting Bracket with 200175E, 200387c and 204791 .....
204791	14313	Presser Bar Lifting Bracket Plate .....
200175E	12308	" " " " " " Screw .....
204720	14313	Presser Bar Lifting Bracket Position Guide .....
200362c	12311	Presser Bar Lifting Bracket Position Guide Set Screw .....
200387c	11897	Presser Bar Lifting Bracket Set Screw .....
204327	12306	Presser Bar Packing Washer (felt) .....
200504E	11897	" " Screw Bushing (lower) .....
204721	14313	" " Spring .....
200491B	12305	" " Thumb Screw (pressure regulating) .....
201506B	12376	Pressure Bar Thumb Screw Check Nut .....
213015	14312	Take-up Cam with 200335c, 200383c, 200387c, 200400c, 200430c and 204479 .....

No.	Plate	Name
231433	12080	Take-up Cam Key .....
200430c	12311	" " Position Screw .....
200383c	12311	" " " " Check Screw .....
200335c	12311	Take-up Cam Set Screw .....
221450	---	Take-up Cam complete, Nos. 204788, 213015 and 231437 .....
204553	12386	Take-up Lever .....
204723	14314	" " Bearing with 204264 .....
204264	12306	" " " Position Pin .....
200042F	12311	" " " Screw .....
201816	12307	" " Roller .....
213109	---	Take-up Lever complete, Nos. 200042F, 201816, 204553 and 204723 .....
202402	12309	Tension Disc .....
202090	12309	" " Position Pin .....
222254	11897	" Release Lever .....
222254	14314	" " " Operating Lever .....
200585H	14314	" " " " " " Screw .....
200309c	10483	Tension Release Lever Screw .....
202075	12309	" " Plunger .....
207876	---	" " Slide .....
206608	13104	" " " Spring .....
207877	---	Tension Release Slide complete, Nos. 207876, 222254 and two 200585H .....
225708	14314	Tension Spring .....
201375A	14314	" Stud .....
200397H	12309	" " Set Screw .....
201572B	10881	" Thumb Nut .....
204271	12309	" Washer .....
221223	14314	Tension complete, Nos. 201375A, 201572B, 202075, 204271, 225708 and two 202402 .....
204274	12309	Thread Controller Plate .....
200577H	12311	" " " Screw .....
202098	12309	" " Roller .....
204275	12309	" " " Guard .....
202084	12309	" " " " Washer .....
200309c	12309	" " " Screw .....
204726	14314	" " Spring .....
204333	12309	" " " Guard .....
200581H	12309	" " " " Screw .....
202087	12079	" " " Stop .....
204795	14314	" " " Stud with 204925 .....
200366H	12309	Thread Controller Spring Stud Set Screw .....

No.	Plate	Name
204925	12306	Thread Controller Spring Stud Washer .....
204730	12386	Thread Controller Thread Guard ..
200397H	12309	" " " " Set Screw .....
205987	12309	Thread Controller complete, Nos. 200300c, 200581n, 202084, 202098, 204274, 204275 and 204333 .....
204731	---	Thread Controller and Spring complete, Nos. 204726 and 205987 ..
203313	12386	Thread Guide .....
204281	12309	" Retainer Guide Wire .....
202091	12309	" " Sleeve .....
202092	12309	" " Spring .....
204058	12309	" " Stud .....
200368H	12309	" " " Set Screw .....
204059	12309	Thread Retainer complete, Nos. 202091, 202092 and 204058 .....
212824	14322	Throat Plate, 40 needle hole, for needle sizes 20 and 22, in $\frac{1}{8}$ in. gauge, for 212825 .....
212245	11829	Throat Plate, 46 needle hole, for needle sizes 16 and 18, in $\frac{3}{16}$ in. gauge, for 212246 .....
212244	11829	Throat Plate, 40 needle hole, for needle sizes 20 and 22, in gauges $\frac{1}{2}$ , $\frac{1}{4}$ and $\frac{3}{16}$ in., for 212246 .....
212026	14321	Throat Plate, 40 needle hole, for needle sizes 20 and 22, in gauges $\frac{1}{8}$ and $\frac{15}{16}$ in., for 211624 .....
211978	11829	Throat Plate, 40 needle hole, for needle sizes 20 and 22, in gauges $\frac{1}{8}$ , $\frac{15}{16}$ , $\frac{1}{4}$ and $\frac{15}{16}$ in., for 211976 ..
211975	11829	Throat Plate, 40 needle hole, for needle sizes 20 and 22, in gauges $\frac{1}{8}$ , $\frac{15}{16}$ , $\frac{1}{4}$ and $\frac{15}{16}$ in., for 211974 ..
212240	14321	Throat Plate, 40 needle hole, for needle sizes 20 and 22, in gauges $\frac{1}{8}$ , $\frac{15}{16}$ , $\frac{1}{4}$ and $\frac{15}{16}$ in., for 212241 ..
212242	14321	Throat Plate, 40 needle hole, for needle sizes 20 and 22, in $\frac{3}{4}$ in. gauge, for 231516 .....
200161D	12319	Throat Plate Clamp Screw .....
202062	12308	" " Position Pin .....
200577H	12311	" " Screw .....
213021	14312	Vibrating Presser Bar with 206108
221438	14314	" " " Adjustable Stop with 200113F .....

No.	Plate	Name
221441	---	Vibrating Presser Bar Adjustable Stop 221438 with 221439 and two 201215F .....
221439	14314	Vibrating Presser Bar Adjustable Stop Finger .....
201215F	14314	Vibrating Presser Bar Adjustable Stop Finger Screw .....
200113F	12225	Vibrating Presser Bar Adjustable Stop Set Screw .....
201534E	12225	Vibrating Presser Bar Adjustable Stop Set Screw Nut .....
204797	14314	Vibrating Presser Bar Spring ....
206108	14314	" " " " Hook
204189	12306	" " " " " "
206671	11839	" " Foot, for 229641 ..
229649	14067	" " " in gauges from $\frac{1}{4}$ to $\frac{3}{4}$ in., in steps of $\frac{1}{16}$ in., for 229648 .....
200098F	12307	Vibrating Presser Foot Screw ....
203357	12079	" " " " Washer

## ACCESSORIES

FOR MACHINE No. 22w34

No.	Plate	Name
200157R	12338	Attachment Screw .....
203208	11242	Bobbin (10) .....
*225482	---	" Case Screw Driver Blade ..
*225483	---	" " " " Handle ..
225497	14383	Bobbin Case Screw Driver complete, Nos. 225482 and 225483 ...
128 x 4	---	Needles, four each, sizes 11, 12 and 13 .....
228213	---	Drip Pan with four wood screws $\frac{1}{2}$ in., No. 5 .....
41400	14383	Machine Rest Pin (wood) .....
120342	14383	Oiler (copper plated) with 120343 ..
120343	14383	" Spout, 3 $\frac{1}{2}$ in. long .....
*225484	---	Screw Driver Blade .....
*225485	---	" " Handle .....
225498	14383	Screw Driver complete (7 $\frac{1}{4}$ in. long), Nos. 225484 and 225485 ..
225554	14383	Wrench (steel) .....

### BOBBIN WINDER

225453	10884	Frame with 202277 and 225438 .....
225454	10884	" Hinge Pin .....
202277	---	" Oil Packing (wick) .....
225438	10884	" " Well Cap .....
225455	10884	" Spring .....
225456	10884	" " Plunger .....
202473	10885	Pulley with 200380c .....
200380c	12319	" Set Screw .....
225381	10884	Spindle .....
225444	10884	Stop Latch .....
200056E	10884	" " Screw .....
225458	10884	" " Thumb Lever .....
225459	10884	" " " Hinge Stud .....
225460	10884	" " " " Joint Stud .....
202478	10884	" " Trip Lever .....
200299H	10884	" " " " Hinge Screw .....
225461	10881	Tension Bracket with 201499R .....
200082D	10881	" " Screw .....
228026	10884	" " " Washer .....
2102	10881	" Disc .....

No.	Plate	Name
202407	10881	Tension Spring .....
201499R	10881	" Stud .....
201572B	10881	" " Thumb Nut .....
225462	10881	Bobbin Winder Tension Bracket complete, Nos. 201572B, 202407, 225461 and two 2102 .....
225433	10885	Bobbin Winder and Tension Bracket Base .....
225382	10885	Universal Bobbin Winder complete, Nos. 200056E, 200082D, 200299H, 202473, 202478, 225381, 225433, 225444, 225453 to 225456, 225458 to 225460, 225462, 228026 and two wood screws $\frac{3}{4}$ in., No. 12, R.H.B.

### KNEE LIFTER

227781	14384	Knee Lifter Rock Lever with 200522c and 200529c .....
227782	---	Knee Lifter Rock Lever 227781 with two each 202451 and 202452 .....
227783	---	Knee Lifter Rock Lever 227782 with 202985 and 227728 .....
202453	14384	Knee Lifter Rock Lever Knee Plate with 200526c .....
202985	---	Knee Lifter Rock Lever Knee Plate 202453 with 202455 .....
202455	12084	Knee Lifter Rock Lever Knee Plate Arm (short) .....
200522c	12319	Knee Lifter Rock Lever Knee Plate Arm Set Screw .....
200526c	12319	Knee Lifter Rock Lever Knee Plate Set Screw .....
202451	14384	Knee Lifter Rock Lever Lug with two wood screws $\frac{3}{4}$ in., No. 12H .....
202452	12319	Knee Lifter Rock Lever Lug Hinge Pin .....
227728	14384	Knee Lifter Rock Lever Rod, 3 in. long, with 227729 .....
*227729	---	Knee Lifter Rock Lever Rod Cap or Oil Guard .....
200529c	12319	Knee Lifter Rock Lever Rod Set Screw .....

(Other Knee Lifter Parts are listed with parts of machine head.)

**THREAD UNWINDER**

No.	Plate	Name
225389	14083	Spool Rest (for one spool) with 201018c .....
225395	14083	Spool Rest (for two spools) with 201018c .....
225388	14083	Spool Rest Rod .....
200383c	12311	" " " Set Screw .....
201018c	14314	" " " Set Screw .....
202490	14083	" Stand with 200383c .....
225391	14083	Thread Guide .....
201696j	14314	" " Lock Nut .....
225392	14083	" " Rod with 208E and 225393 .....
208E	14314	Thread Guide Rod Screw .....
225393	14314	" " " Washer .....
225397	14083	Thread Unwinder (for three spools) complete, Nos. 201696j, 202490, 225388, 225389, 225392, 225395, three each 225391 and wood screws 7/8 in., No. 12 .....

**FOR MACHINES NOS. 22w39 and 22w40**

Same as for No. 22w34 with the following exceptions:

203470	11249	Bobbin (10), in place of 203208 ...
207805	12079	Knife (3) .....
225487	14314	Roller Presser Hinge Screw Nut Wrench .....

**FOR MACHINE No. 22w125**

Same as for No. 22w34 with the following exceptions:

225487	14314	Roller Presser Hinge Screw Nut Wrench .....
--------	-------	---

**KNEE LIFTER**

227781	14384	Knee Lifter Rock Lever with 200522c and 200529c .....
227782	---	Knee Lifter Rock Lever 227781 with two each 202451 and 202452 ....
227787	14384	Knee Lifter Rock Lever 227782 with 202203 and 227728, in place of 227783 .....
202453	14384	Knee Lifter Rock Lever Knee Plate with 200526c .....

No.	Plate	Name
202203	---	Knee Lifter Rock Lever Knee Plate 202453 with 202454 .....
202454	14384	Knee Lifter Rock Lever Knee Plate Arm (long) .....
200522c	12319	Knee Lifter Rock Lever Knee Plate Arm Set Screw .....
200526c	12319	Knee Lifter Rock Lever Knee Plate Set Screw .....
202451	14384	Knee Lifter Rock Lever Lug with two wood screws 7/8 in., No. 12H
202452	12319	Knee Lifter Rock Lever Lug Hinge Pin .....
227728	14384	Knee Lifter Rock Lever Rod, 3 in. long, with 227729 .....
*227729	---	Knee Lifter Rock Lever Rod Cap or Oil Guard .....
200529c	12319	Knee Lifter Rock Lever Rod Set Screw .....

(Other Knee Lifter Parts are listed with parts of machine head.)

**FOR MACHINES NOS. 22w172 and 22w173**

Same as for No. 22w34 with the following exceptions:

203470	11249	Bobbin (10), in place of 203208 ...
227787	14384	Knee Lifter Rock Lever, in place of 227783 .....
225487	14314	Roller Presser Hinge Screw Nut Wrench .....

**FOR MACHINE No. 22w206**

Same as for No. 22w34 with the following exceptions:

203470	11249	Bobbin (10), in place of 203208 ...
227787	14384	Knee Lifter Rock Lever, in place of 227783 .....
225487	14314	Roller Presser Hinge Screw Nut Wrench .....
129 x 2	---	Needles, twelve, size 22, in place of 128 x 4 .....

## MISCELLANEOUS PARTS

Used in Conjunction with Thread Unwinder

No.	Plate	Name
60913	14083	Spool Weight .....
60914	—	" " Center Pin .....
225377	14083	" Wire, for small spools .....

## FEED DOGS

FOR ALL MACHINES OF CLASS 22w EXCEPT  
NOS. 22w172 AND 22w173

210999	11825	Feed Dog, for 211049 .....
236411	14318	" " " 211069 to 211071 .....
236419	14318	" " " 211072 to 211074 .....
211298	14317	" " " 212133, 212134 and 212224 .....
211630	14317	Feed Dog, for 212109 and 212110 ..
211650	11874	" " " 212099, 212111, 212112 and 212165 .....
211652	11874	Feed Dog, for 212113 and 212114 ..
211674	11874	" " " 212271 .....
211675	11874	" " " 212271 .....
211679	14315	" " " 212272 .....
211680	14315	" " " 212272 .....
211684	14315	" " " 212273 .....
211685	14315	" " " 212273 .....
211739	14316	" " " 203777 .....
211740	14316	" " " 203777 .....
211623	14316	" " " 212025 and 212026 ..
211624	14316	" " " 212025 and 212026 ..
211805	14318	" " " 221459 .....
211974	11829	" " " 211975 .....
211976	11829	" " " 211977 to 211980 and 222240 .....
211982	14316	Feed Dog, for 211975 .....
212103	14317	" " " 212196, 212197 and 212223 .....

No.	Plate	Name
212104	14317	Feed Dog, for 212196, 212197 and 212223 .....
211809	11874	Feed Dog, for 211952 .....
222324	14315	" " " 222325 .....
236423	14318	" " " 211190, 212088 and 212166 .....
212169	14318	Feed Dog, for 211195 to 211197 .....
212241	14315	" " " 212240 .....
212246	11829	" " " 212244 and 212245 ..
212825	14315	" " " 212824 and 222230 ..
212252	11825	" " " 212251 .....
212474	14318	" " " 211192 to 211194 .....
212571	14317	" " " 211068, 212569 and 212570 .....
222227	14316	Feed Dog, for 222228 .....
222267	14317	" " " 222259 and 222261 ..
222268	14317	" " " 222260 and 222262 ..
222288	14318	" " " 222289 to 222291 .....
222322	14315	" " " 222323 .....
231516	14316	" " " 212242 .....

FOR MACHINE No. 22w172

211588	11874	Feed Dog, 50 needle hole, for needle sizes 14 and 15, in gauges $\frac{1}{16}$ , $\frac{3}{32}$ and $\frac{1}{8}$ in., for 211587 .....
--------	-------	---

FOR MACHINE No. 22w173

211296	12078	Feed Dog, 40 needle hole, for needle sizes 20 and 22, in gauges $\frac{1}{16}$ , $\frac{3}{32}$ , $\frac{1}{8}$ and $\frac{3}{16}$ in., for 211589 .....
211590	12078	Feed Dog, 50 needle hole, for needle sizes 14 and 15, in gauges from $\frac{1}{16}$ to $\frac{3}{16}$ in., in steps of $\frac{1}{32}$ in., for 211589 .....
211591	12078	Feed Dog, 46 needle hole, for needle sizes 16 and 18, in gauges from $\frac{1}{8}$ to $\frac{3}{16}$ in., in steps of $\frac{1}{32}$ in., for 211589 .....

## NEEDLE HOLDERS

No.	Plate	Name
231381	11832	Needle Holder, needles $\frac{3}{16}$ in. apart and must be set diagonally, in gauges $\frac{3}{16}$ , $\frac{5}{16}$ , $\frac{7}{16}$ and $\frac{1}{4}$ in., with 201030F and two 200141F, for Machine No. 22w172 .....
231388	11832	Needle Holder, needles $\frac{3}{16}$ in. apart and must be set diagonally, in gauges $\frac{3}{16}$ , $\frac{5}{16}$ and $\frac{1}{4}$ in., with 201030F and two 200141F, for Machines Nos. 22w34 and 22w125 ..
231382	11832	Needle Holder, needles $\frac{1}{4}$ in. apart and must be set diagonally, in gauges $\frac{3}{16}$ , $\frac{5}{16}$ , $\frac{7}{16}$ , $\frac{1}{4}$ and $\frac{5}{16}$ in., with 201030F and two 200141F, for Machines Nos. 22w34, 22w125 and 22w172 .....
231383	11832	Needle Holder, in gauges from $\frac{3}{16}$ to $\frac{1}{2}$ in., in steps of $\frac{1}{32}$ in., with 201030F and two 200141F, for Machines Nos. 22w34, 22w125 and 22w206 .....
231385	11832	Needle Holder, in gauges from $\frac{1}{8}$ to $\frac{3}{4}$ in., in steps of $\frac{1}{32}$ in., with 201030F and two 200141F, for Machines Nos. 22w34, 22w125 and 22w206 .....
231398	11832	Needle Holder, in gauges from $\frac{3}{16}$ to $\frac{5}{16}$ in., in steps of $\frac{1}{32}$ in., with 201030F and two 200141F, for Machine No. 22w173 .....
203708	11832	Needle Holder, needles $\frac{3}{16}$ in. apart and must be set diagonally, in gauges $\frac{3}{16}$ , $\frac{5}{16}$ and $\frac{1}{4}$ in., for trimming .035, .045 and .060 in., with two each 200141F and 200381U, for Needle Bar 203715, for Machine No. 22w39 .....
229662	11832	Needle Holder, in gauges from $\frac{3}{16}$ to $\frac{1}{4}$ in., in steps of $\frac{1}{32}$ in., for trimming .045, .060, .085 and .125 in., with 200141F, 200389C and two 200581U, for Needle Bar 203715, for Machine No. 22w40 .....

No.	Plate	Name
229966	---	Needle Holder, in gauges from $\frac{3}{16}$ to $\frac{1}{4}$ in., in steps of $\frac{1}{32}$ in., for trimming .035, .045 and .060 in., with two each 200389C and 200581U, for Needle Bar 203715, for Machine No. 22w40 .....
231400	14317	Needle Holder, in gauges from $\frac{1}{4}$ to $\frac{3}{4}$ in., in steps of $\frac{1}{16}$ in., for trimming .045, .060 and .085 in., with 201030F and two 200389C, for Needle Bar 231390, for Machine No. 22w40 .....

## PRESSER FEET

FOR MACHINES NOS. 22w34 and 22w125

206658	11837	Lifting Presser Foot, 46 needle hole, needles $\frac{3}{16}$ in. apart, in gauges $\frac{3}{16}$ , $\frac{5}{16}$ and $\frac{1}{4}$ in., for 206678
206666	11837	Lifting Presser Foot, 46 needle hole, needles $\frac{3}{16}$ in. apart, in gauges $\frac{3}{16}$ , $\frac{5}{16}$ and $\frac{1}{4}$ in., for 206668
206667	11837	Lifting Presser Foot, 50 needle hole, needles $\frac{3}{16}$ in. apart, in gauges $\frac{3}{16}$ , $\frac{5}{16}$ and $\frac{1}{4}$ in., for 206668
206669	11837	Lifting Presser Foot, 46 needle hole, in gauges $\frac{3}{16}$ and $\frac{1}{4}$ in., for 206670 .....
206677	11837	Lifting Presser Foot, 46 needle hole, needles $\frac{1}{4}$ in. apart, in gauges $\frac{3}{16}$ , $\frac{5}{16}$ and $\frac{1}{4}$ in., for 206678
206708	11837	Lifting Presser Foot, 50 needle hole, in gauges $\frac{3}{16}$ and $\frac{1}{4}$ in., for 206710 .....
206709	11837	Lifting Presser Foot, 46 needle hole, in gauges $\frac{3}{16}$ and $\frac{1}{4}$ in., for 206710 .....
206711	11837	Lifting Presser Foot, 46 needle hole, in gauges $\frac{3}{16}$ and $\frac{1}{4}$ in., for 206713 .....

No.	Plate	Name
206712	11837	Lifting Presser Foot, 50 needle hole, in gauges $\frac{3}{16}$ and $\frac{1}{4}$ in., for 206713 .....
206718	11837	Lifting Presser Foot, 46 needle hole, in gauges $\frac{1}{8}$ and $\frac{3}{16}$ in., for 206670 .....
206720	11837	Lifting Presser Foot, 50 needle hole, in $\frac{3}{16}$ in. gauge, for 206670 .....
229624	11837	Lifting Presser Foot, in $\frac{1}{4}$ in. gauge, for 206675 and 206714 .....
229637	14315	Lifting Presser Foot, 46 needle hole, in $\frac{3}{16}$ in. gauge, for 206675 and 206714 .....
229638	14066	Lifting Presser Foot, 46 needle hole, needles $\frac{1}{4}$ in. apart, in $\frac{1}{8}$ in. gauge, for 206678 .....
229640	14066	Lifting Presser Foot, 46 needle hole, needles $\frac{3}{16}$ in. apart, in gauges $\frac{3}{16}$ , $\frac{1}{4}$ and $\frac{1}{2}$ in., for 206668, 206675 and 206714 .....
229641	14066	Lifting Presser Foot, 46 needle hole, in gauges $\frac{3}{16}$ , $\frac{1}{4}$ , $\frac{5}{16}$ , $\frac{3}{8}$ and $\frac{1}{2}$ in., for 206671 .....
229642	14066	Lifting Presser Foot, 46 needle hole, in gauges $\frac{3}{16}$ and $\frac{1}{4}$ in., for 206661 and 229643 .....
229644	11837	Lifting Presser Foot, 50 needle hole, in $\frac{3}{16}$ in. gauge, for 206675 and 206714 .....
229646	14067	Lifting Presser Foot, 50 needle hole, in gauges $\frac{3}{16}$ , $\frac{1}{4}$ and $\frac{1}{2}$ in., for 206690 .....
229650	14067	Lifting Presser Foot, 46 needle hole, in gauges $\frac{1}{8}$ , $\frac{3}{16}$ , $\frac{1}{4}$ , $\frac{5}{16}$ and $\frac{3}{8}$ in., for 229651 .....
229652	14067	Lifting Presser Foot, 46 needle hole, in gauges from $\frac{3}{16}$ to $\frac{1}{2}$ in., in steps of $\frac{1}{16}$ in., for 229653 .....
229654	14315	Lifting Presser Foot, 46 needle hole, in gauges $\frac{3}{16}$ , $\frac{1}{4}$ , $\frac{5}{16}$ and $\frac{3}{8}$ in., for 229655 .....
206661	11839	Vibrating Presser Foot, for 229642
206668	11839	" " " " 206666, 206667 and 229640 .....
206670	11839	Vibrating Presser Foot, for 206669, 206718 and 206720 .....
206675	11839	Vibrating Presser Foot, for 229624, 229637, 229640 and 229644 .....
206678	11839	Vibrating Presser Foot, for 206658, 206677 and 229638 .....

No.	Plate	Name
206690	11839	Vibrating Presser Foot, for 229646
206710	11839	" " " " 206708 and 206709 .....
206713	11839	Vibrating Presser Foot, for 206711 and 206712 .....
206714	11839	Vibrating Presser Foot, for 229624, 229637, 229640 and 229644 .....
229651	14067	Vibrating Presser Foot, for 229650
229653	14067	" " " in gauges from $\frac{3}{16}$ to $\frac{1}{2}$ in., in steps of $\frac{1}{16}$ in., for 229652 .....
229655	14315	Vibrating Presser Foot, in gauges $\frac{3}{16}$ , $\frac{1}{4}$ , $\frac{5}{16}$ and $\frac{3}{8}$ in., for 229654 .....
206671	11839	Vibrating Presser Foot, for 229641

## FOR MACHINE No. 22w206

229641	14066	Lifting Presser Foot, 46 needle hole, in gauges $\frac{3}{16}$ , $\frac{1}{4}$ , $\frac{5}{16}$ , $\frac{3}{8}$ and $\frac{1}{2}$ in., for 206671 .....
229646	14067	Lifting Presser Foot, 46 needle hole, in gauges $\frac{3}{16}$ , $\frac{1}{4}$ and $\frac{1}{2}$ in., for 206690 .....
229648	14067	Lifting Presser Foot, 46 needle hole, in gauges from $\frac{1}{4}$ to $\frac{3}{4}$ in., in steps of $\frac{1}{8}$ in., for 229649 .....
229650	14067	Lifting Presser Foot, 46 needle hole, in gauges $\frac{1}{8}$ , $\frac{3}{16}$ , $\frac{1}{4}$ , $\frac{5}{16}$ and $\frac{3}{8}$ in., for 229651 .....
229652	14068	Lifting Presser Foot, 46 needle hole, in gauges from $\frac{3}{16}$ to $\frac{1}{2}$ in., in steps of $\frac{1}{16}$ in., for 229653 .....
229654	14315	Lifting Presser Foot, 46 needle hole, in gauges $\frac{3}{16}$ , $\frac{1}{4}$ , $\frac{5}{16}$ and $\frac{3}{8}$ in., for 229655 .....
206682	14067	Lifting Presser Foot, 35 needle hole, in gauges from $\frac{1}{4}$ to $\frac{3}{4}$ in., in steps of $\frac{1}{8}$ in., for 229649 .....
222229	14066	Lifting Presser Foot, 40 needle hole, in gauges $\frac{3}{16}$ , $\frac{1}{4}$ and $\frac{1}{2}$ in., for 206671 .....
206671	11839	Vibrating Presser Foot, for 222229 and 229641 .....
206690	11839	Vibrating Presser Foot, for 229646
229649	14067	" " " in gauges from $\frac{1}{4}$ to $\frac{3}{4}$ in., in steps of $\frac{1}{8}$ in., for 206682 and 229648 .....
229655	14315	Vibrating Presser Foot, in gauges $\frac{3}{16}$ , $\frac{1}{4}$ , $\frac{5}{16}$ and $\frac{3}{8}$ in., for 229654 .....



## ROLLER PRESSERS

FOR MACHINES NOS. 22w39, 22w40, 22w172  
AND 22w173

No.	Plate	Name
201906	11845	Roller Presser, $1\frac{1}{4}$ in. diam., $\frac{3}{16}$ in. face (fine), with 200548c and 201534n
201907	11845	Roller Presser, $1\frac{1}{4}$ in. diam., $\frac{3}{16}$ in. face (fine), with 200548c and 201534n
201908	11845	Roller Presser, $1\frac{1}{4}$ in. diam., $\frac{1}{8}$ in. face (fine), with 200548c and 201534n
201909	11845	Roller Presser, $\frac{3}{4}$ in. diam., $\frac{3}{16}$ in. face (coarse) with 200551c and 201534n
201910	12225	Roller Presser, $\frac{3}{4}$ in. diam., $\frac{1}{8}$ in. face (coarse), with 200551c and 201534n
201911	11845	Roller Presser, 1 in. diam., $\frac{1}{8}$ in. face (coarse), with 200551c and 201534n
202839	-----	Roller Presser Arm
204328	-----	" " "
204567	11845	" " " 202839 with 201906
204570	12225	Roller Presser Arm 204328 with 201910
229341	14307	Roller Presser Arm Bracket (swing)
229344	-----	Roller Presser Arm Bracket 229341 with 200096b, 201071f, 204567 and 229325
229747	-----	Roller Presser Arm Bracket 229341 with 200096b, 201071f, 204567 and 229326
200675c	12225	Roller Presser Arm Bracket Position Screw Stud
202558	12225	Roller Presser Arm Bracket Spring
202559	12225	" " " " "
200441f	11897	Roller Presser Arm Bracket Spring Stop Screw
229370	12079	Roller Presser Arm Bracket Spring Stop and Back Needle Guard Holder

No.	Plate	Name
229371	-----	Roller Presser Arm Bracket Spring Stop and Back Needle Guard Holder 229370 with 200350n, 201317f and 226220
200350n	11845	Roller Presser Arm Bracket Spring Stop and Back Needle Guard Holder Adjusting Screw
200441f	11897	Roller Presser Arm Bracket Spring Stop and Back Needle Guard Holder Set Screw
200096b	12225	Roller Presser Arm Screw, for gauges $\frac{3}{16}$ to $\frac{1}{4}$ inch
200082b	10881	Roller Presser Arm Screw, for gauges $\frac{3}{16}$ to $\frac{1}{4}$ inch
200077b	14307	Roller Presser Arm Screw, for gauges $\frac{3}{16}$ and $\frac{1}{4}$ inch
200064b	14307	Roller Presser Arm Screw, for gauges $\frac{1}{8}$ and $\frac{3}{16}$ inch
229744	14307	Roller Presser Arm Shim, $\frac{3}{16}$ in. thick
229745	14307	Roller Presser Arm Shim, $\frac{1}{8}$ in. thick
202760	14307	Roller Presser Arm Shim, $\frac{1}{16}$ in. thick
204495	12225	Roller Presser Bar
200548c	14307	" " Hinge Screw
200551c	12225	" " " "
201534n	12225	" " " " Nut
229328	14309	" " Needle Guard (back), in gauges $\frac{3}{16}$ , $\frac{1}{4}$ , $\frac{3}{8}$ and $\frac{1}{2}$ inch
229329	14309	Roller Presser Needle Guard (back), in $\frac{1}{8}$ in. gauge
229330	14309	Roller Presser Needle Guard (back), in $\frac{3}{16}$ in. gauge
229331	14309	Roller Presser Needle Guard (back), in $\frac{1}{4}$ in. gauge
229332	14309	Roller Presser Needle Guard (back), in $\frac{3}{8}$ in. gauge
229333	14309	Roller Presser Needle Guard (back), in $\frac{1}{2}$ in. gauge, with 350061f
229334	14309	Roller Presser Needle Guard (back), in $\frac{3}{8}$ in. gauge, with 350061f
229335	14309	Roller Presser Needle Guard (back), in $\frac{1}{4}$ in. gauge, with 350061f
229347	14314	Roller Presser Needle Guard (back), in $\frac{3}{16}$ in. gauge, with 350061f

No.	Plate	Name
229338	14309	Roller Presser Needle Guard (back), in gauges $\frac{3}{8}$ , $\frac{1}{2}$ and $\frac{5}{8}$ in., with 200175c and 229339 .....
215918	14309	Roller Presser Needle Guard (back), in gauges $\frac{3}{8}$ , $\frac{1}{2}$ and $\frac{1}{4}$ in., with 200175c, 213699 and 350061f .....
229340	14309	Roller Presser Needle Guard (back), in gauges $\frac{3}{8}$ , $\frac{1}{2}$ and $\frac{1}{4}$ in., with 200134c, 200175c and 213699 .....
229349	---	Roller Presser Needle Guard (back), in $\frac{3}{8}$ in. gauge .....
229360	---	Roller Presser Needle Guard (back), in $\frac{3}{8}$ in. gauge .....
229361	---	Roller Presser Needle Guard (back), in $\frac{1}{2}$ in. gauge .....
229362	---	Roller Presser Needle Guard (back), in $\frac{3}{8}$ in. gauge, with 350061f .....
229363	---	Roller Presser Needle Guard (back), in $\frac{1}{4}$ in. gauge, with 350061f .....
229364	---	Roller Presser Needle Guard (back), in $\frac{3}{8}$ in. gauge, with 350061f .....
222300	---	Roller Presser Needle Guard (back), in $\frac{1}{4}$ in. gauge, with 200397H, for use when trimming .035 or .045 in. from seam .....
201317F	12079	Roller Presser Needle Guard (back) Clamp Screw .....
226220	14307	Roller Presser Needle Guard (back) Clamp Screw Washer ..
209397H	12309	Roller Presser Needle Guard (back) Screw .....
350061F	14314	Roller Presser Needle Guard (back) Screw .....
201316F	14314	Roller Presser Needle Guard (back) Screw .....
200134c	14307	Roller Presser Needle Guard (back) Screw .....
213699	14309	Roller Presser Needle Guard (back) Spring Guide .....
229339	14309	Roller Presser Needle Guard (back) Spring Guide .....
200175c	12308	Roller Presser Needle Guard (back) Spring Guide Screw ....
229325	11845	Roller Presser Needle Guard (front), in gauges $\frac{1}{4}$ , $\frac{3}{8}$ , $\frac{1}{2}$ and $\frac{5}{8}$ inch .....

No.	Plate	Name
229326	14314	Roller Presser Needle Guard (front), in gauges $\frac{1}{4}$ , $\frac{3}{8}$ , $\frac{1}{2}$ and $\frac{5}{8}$ inch .....
201071F	11845	Roller Presser Needle Guard (front) Screw .....
229345	14308	Roller Presser and Bar complete, in gauges $\frac{1}{4}$ , $\frac{3}{8}$ , $\frac{1}{2}$ and $\frac{5}{8}$ in., Nos. 200675c, 202558, 204495, 229328, 229344, 229371 and two 200141F .....
229346	14308	Roller Presser and Bar complete, in $\frac{3}{8}$ in. gauge, Nos. 200082D, 200675c, 202558, 204495, 204567, 229330, 229341, 229371, 229744, 229745 and two 200141F .....
229950	---	Roller Presser and Bar complete, in $\frac{1}{4}$ in. gauge, Nos. 200082D, 200675c, 202558, 202760, 204495, 204567, 229331, 229341, 229371 and two 200141F .....
229951	---	Roller Presser and Bar complete, in $\frac{3}{8}$ in. gauge, Nos. 200077D, 200675c, 202558, 202760, 204495, 204567, 229332, 229341, 229371, 229744 and two 200141F .....
229952	---	Roller Presser and Bar complete, in $\frac{3}{8}$ in. gauge, Nos. 200077D, 200675c, 202558, 202760, 204495, 204567, 229341, 229347, 229371, 229745 and two 200141F .....
229953	---	Roller Presser and Bar complete, in $\frac{1}{2}$ in. gauge, Nos. 200077D, 200675c, 202558, 202760, 204495, 204567, 229334, 229341, 229371, 229744, 229745 and two 200141F ..
229954	---	Roller Presser and Bar complete, in $\frac{1}{4}$ in. gauge, Nos. 200064D, 200675c, 202558, 204495, 204567, 229335, 229341, 229371, two each 200141F and 202760 .....
229748	14308	Roller Presser and Bar complete, in gauges $\frac{1}{4}$ , $\frac{3}{8}$ , $\frac{1}{2}$ and $\frac{5}{8}$ in., Nos. 200675c, 202558, 202559, 204495, 229747 and two 200141F ..
229957	---	Roller Presser and Bar complete, in $\frac{3}{8}$ in. gauge, Nos. 200082D, 200675c, 202558, 204495, 204567, 229341, 229360, 229371, 229744, 229745 and two 200141F .....

No.	Plate	Name
229958	-----	Roller Presser and Bar complete, in $\frac{1}{8}$ in. gauge, Nos. 200082b, 200675c, 202558, 202760, 204495, 204567, 229341, 229361, 229371 and two 200141F .....
229350	-----	Roller Presser and Bar complete, in $\frac{1}{8}$ in. gauge, Nos. 200082b, 200675c, 202558, 202760, 204495, 204567, 229341, 229349, 229371, 229744, 229745 and two 200141F .....
229959	-----	Roller Presser and Bar complete, in $\frac{1}{8}$ in. gauge, Nos. 200077b, 200675c, 202558, 202760, 204495, 204567, 229333, 229341, 229371, 229745 and two 200141F .....
229960	-----	Roller Presser and Bar complete, in $\frac{1}{8}$ in. gauge, Nos. 200077b, 200675c, 202558, 202760, 204495, 204567, 229341, 229362, 229371, 229744, 229745 and two 200141F .....
229961	-----	Roller Presser and Bar complete, in $\frac{1}{8}$ in. gauge, Nos. 200064b, 200675c, 202558, 204495, 204567, 229341, 229363, 229371, two each 200141F and 202760 .....
229962	-----	Roller Presser and Bar complete, in $\frac{1}{8}$ in. gauge, Nos. 200064b, 200675c, 202558, 204495, 204567, 229341, 229364, 229371, 229744, two each 200141F and 202760 ..

## THROAT PLATES

FOR MACHINES NOS. 22w34 and 22w125

No.	Plate	Name
203777	14320	Throat Plate, 46 needle hole, for needle sizes 16 and 18, in gauges from $\frac{1}{8}$ to $\frac{1}{4}$ in., in steps of $\frac{1}{16}$ in., for 211739 and 211740 .....
211049	11825	Throat Plate, 46 needle hole, needles $\frac{1}{8}$ in. apart, for needle sizes 16 and 18, in gauges $\frac{1}{8}$ and $\frac{1}{4}$ in., for 210999 .....
211068	11825	Throat Plate, 46 needle hole, for needle sizes 16 and 18, in gauges $\frac{1}{8}$ and $\frac{1}{4}$ in., for 212571 .....
211069	11824	Throat Plate, 53 needle hole, for needle sizes 12 and 13, in gauges $\frac{1}{8}$ and $\frac{1}{4}$ in., for 236411 .....
211070	11824	Throat Plate, 50 needle hole, for needle sizes 14 and 15, in gauges $\frac{1}{8}$ and $\frac{1}{4}$ in., for 236411 .....
211071	11824	Throat Plate, 46 needle hole, for needle sizes 16 and 18, in gauges $\frac{1}{8}$ and $\frac{1}{4}$ in., for 236411 .....
211072	11824	Throat Plate, 53 needle hole, for needle sizes 12 and 13, in gauges $\frac{1}{8}$ and $\frac{1}{4}$ in., for 236419 .....
211073	11824	Throat Plate, 50 needle hole, for needle sizes 14 and 15, in $\frac{1}{8}$ in. gauge, for 236419 .....
211074	11824	Throat Plate, 46 needle hole, for needle sizes 16 and 18, in gauges $\frac{1}{8}$ and $\frac{1}{4}$ in., for 236419 .....
211190	11824	Throat Plate, 53 needle hole, for needle sizes 12 and 13, in gauges $\frac{1}{8}$ and $\frac{1}{4}$ in., for 236423 .....
211192	11824	Throat Plate, 53 needle hole, for needle sizes 12 and 13, in gauges $\frac{1}{8}$ and $\frac{1}{4}$ in., for 212474 .....
211193	11824	Throat Plate, 50 needle hole, for needle sizes 14 and 15, in gauges $\frac{1}{8}$ and $\frac{1}{4}$ in., for 212474 .....
211194	11824	Throat Plate, 46 needle hole, for needle sizes 16 and 18, in gauges $\frac{1}{8}$ and $\frac{1}{4}$ in., for 212474 .....

No.	Plate	Name
211195	11824	Throat Plate, 53 needle hole, for needle sizes 12 and 13, in gauges $\frac{13}{32}$ and $\frac{1}{2}$ in., for 212169 .....
211196	11824	Throat Plate, 50 needle hole, for needle sizes 14 and 15, in gauges $\frac{13}{32}$ and $\frac{1}{2}$ in., for 212169 .....
211197	11824	Throat Plate, 46 needle hole, for needle sizes 16 and 18, in gauges $\frac{13}{32}$ and $\frac{1}{2}$ in., for 212169 .....
212088	11824	Throat Plate, 50 needle hole, for needle sizes 14 and 15, in gauges $\frac{13}{32}$ and $\frac{3}{4}$ in., for 236423 .....
212099	14323	Throat Plate, 46 needle hole, needles $\frac{3}{8}$ in. apart, for needle sizes 16 and 18, in gauges $\frac{3}{8}$ and $\frac{1}{2}$ in., for 211650 .....
212110	14320	Throat Plate, 50 needle hole, needles $\frac{3}{8}$ in. apart, for needle sizes 14 and 15, in gauges $\frac{13}{32}$ , $\frac{3}{8}$ and $\frac{1}{2}$ in., for 211630 .....
212111	14323	Throat Plate, 53 needle hole, needles $\frac{3}{8}$ in. apart, for needle sizes 12 and 13, in gauges $\frac{13}{32}$ , $\frac{3}{8}$ and $\frac{1}{2}$ in., for 211650 .....
212112	14323	Throat Plate, 50 needle hole, needles $\frac{3}{8}$ in. apart, for needle sizes 14 and 15, in gauges $\frac{13}{32}$ , $\frac{3}{8}$ and $\frac{1}{2}$ in., for 211650 .....
212113	14323	Throat Plate, 53 needle hole, for needle sizes 12 and 13, in gauges $\frac{13}{32}$ and $\frac{1}{2}$ in., for 211652 .....
212114	14323	Throat Plate, 50 needle hole, for needle sizes 14 and 15, in gauges $\frac{13}{32}$ and $\frac{1}{2}$ in., for 211652 .....
212133	14320	Throat Plate, 53 needle hole, for needle sizes 12 and 13, in gauges $\frac{13}{32}$ , $\frac{1}{2}$ and $\frac{3}{4}$ in., for 211298 .....
212134	14320	Throat Plate, 50 needle hole, for needle sizes 14 and 15, in gauges $\frac{13}{32}$ , $\frac{1}{2}$ and $\frac{3}{4}$ in., for 211298 .....
212165	11825	Throat Plate, 50 needle hole, for needle sizes 14 and 15, in gauges $\frac{13}{32}$ and $\frac{1}{2}$ in., for 211650 .....
212166	11824	Throat Plate, 46 needle hole, for needle sizes 16 and 18, in gauges $\frac{13}{32}$ and $\frac{3}{4}$ in., for 236423 .....
212224	11825	Throat Plate, 46 needle hole, for needle sizes 16 and 18, in gauges $\frac{13}{32}$ and $\frac{1}{2}$ in., for 211298 .....

No.	Plate	Name
212251	11825	Throat Plate, 46 needle hole, for needle sizes 16 and 18, in $\frac{1}{2}$ in. gauge, for 212152 .....
212271	14320	Throat Plate, 50 needle hole, for needle sizes 14 and 15, in gauges $\frac{13}{32}$ , $\frac{3}{8}$ and $\frac{13}{32}$ in., for 211674 and 211675 .....
212272	14320	Throat Plate, 50 needle hole, for needle sizes 14 and 15, in gauges $\frac{3}{8}$ , $\frac{13}{32}$ and $\frac{13}{32}$ in., for 211679 and 211680 .....
212273	14323	Throat Plate, 50 needle hole, for needle sizes 14 and 15, in gauges $\frac{13}{32}$ and $\frac{3}{4}$ in., for 211684 and 211685 .....
212569	11825	Throat Plate, 50 needle hole, for needle sizes 14 and 15, in gauges $\frac{13}{32}$ and $\frac{13}{32}$ in., for 212571 .....
212570	11825	Throat Plate, 53 needle hole, for needle sizes 12 and 13, in gauges $\frac{13}{32}$ and $\frac{13}{32}$ in., for 212571 .....
212109	14320	Throat Plate, 53 needle hole, needles $\frac{3}{8}$ in. apart, for needle sizes 12 and 13, in gauges $\frac{13}{32}$ , $\frac{3}{8}$ and $\frac{1}{2}$ in., for 211630 .....
222230	14322	Throat Plate, 40 needle hole, for needle sizes 20 and 22, in $\frac{1}{4}$ in. gauge, for 212825 .....
222259	14322	Throat Plate, 50 needle hole, for needle sizes 14 and 15, in gauges $\frac{13}{32}$ , $\frac{1}{2}$ and $\frac{3}{4}$ in., for 222267 .....
222260	14322	Throat Plate, 50 needle hole, for needle sizes 14 and 15, in gauges $\frac{13}{32}$ and $\frac{3}{4}$ in., for 222268 .....
222261	14322	Throat Plate, 50 needle hole, for needle sizes 14 and 15, in gauges $\frac{13}{32}$ , $\frac{1}{2}$ and $\frac{3}{4}$ in., for 222267 .....
222262	14322	Throat Plate, 50 needle hole, for needle sizes 14 and 15, in gauges $\frac{13}{32}$ and $\frac{3}{4}$ in., for 222268 .....

## FOR MACHINE No. 22w39

212196	12158	Throat Plate, 53 needle hole, needles $\frac{3}{8}$ in. apart, for needle sizes 12 and 13, in gauges $\frac{13}{32}$ , $\frac{3}{8}$ and $\frac{1}{2}$ in., with 200178D, 200587D, 211416 and 211426, trims opposite the needle and .045, .060 and .085 in. to right of seam, for 212103 and 212104 .....
--------	-------	---

No.	Plate	Name
212197	12158	Throat Plate, 50 needle hole, needles $\frac{3}{16}$ in. apart, for needle sizes 14 and 15, in gauges $\frac{1}{16}$ , $\frac{3}{16}$ and $\frac{1}{8}$ in., with 200178D, 200587D, 211416 and 211426, trims opposite the needle and .060 and .085 in. to right of seam, for 212103 and 212104 .....
212223	12158	Throat Plate, 56 needle hole, needles $\frac{3}{16}$ in. apart, for needle sizes 10 and 11, in gauges $\frac{1}{16}$ , $\frac{3}{16}$ and $\frac{1}{8}$ in., with 200178D, 200587D, 211416 and 211426, trims opposite the needle and .035, .045, .060 and .085 in. to right of seam, for 212104 .....

## FOR MACHINE No. 22w40

221459	---	Throat Plate, 50 needle hole, for needle sizes 14 and 15, in $\frac{1}{4}$ in. gauge, with 200178D, 200587D, 211416 and 211426, trims opposite the needle and .060 and .085 in. to right of seam, for 211805 ....
211952	14325	Throat Plate, 50 needle hole, for needle sizes 14 and 15, in gauges from $\frac{1}{16}$ to $\frac{3}{16}$ in., in steps of $\frac{1}{16}$ in., with 200178D, 200587D, 211416 and 211426, trims opposite the needle and .060 and .085 in. to right of seam, for 211809 .....
222323	14325	Throat Plate, 56 needle hole, for needle sizes 10 and 11, in $\frac{1}{4}$ in. gauge, with 200178D, 200587D, 211416 and 211426, trims opposite the needle and .035 and .045 in. to right of seam, for 222322 ....
222325	14325	Throat Plate, 50 needle hole, for needle sizes 14 and 15, in gauges $\frac{1}{16}$ , $\frac{3}{16}$ and $\frac{1}{8}$ in., with 200178D, 200587D, 211416 and 211426, trims opposite the needle and .060 and .085 in. to right of seam, for 222324 .....

## FOR MACHINE No. 22w172

211587	11874	Throat Plate, in gauges $\frac{1}{16}$ , $\frac{3}{16}$ and $\frac{1}{8}$ in., for 211588 .....
--------	-------	---

## FOR MACHINE No. 22w173

No.	Plate	Name
211589	12078	Throat Plate, in gauges from $\frac{1}{16}$ to $\frac{1}{8}$ in., in steps of $\frac{1}{16}$ in., for 211296, 211590 and 211591 .....

## FOR MACHINE No. 22w206

211975	11829	Throat Plate, 40 needle hole, for needle sizes 20 and 22, in gauges $\frac{1}{16}$ , $\frac{3}{16}$ , $\frac{1}{8}$ , $\frac{3}{8}$ and $\frac{1}{2}$ in., for 211974 and 211982 .....
211977	11829	Throat Plate, 46 needle hole, for needle sizes 16 and 18, in gauges from $\frac{1}{16}$ to $\frac{1}{8}$ in., in steps of $\frac{1}{16}$ in., for 211976 .....
211978	11829	Throat Plate, 40 needle hole, for needle sizes 20 and 22, in gauges from $\frac{1}{16}$ to $\frac{1}{8}$ in., in steps of $\frac{1}{16}$ in., for 211976 .....
211979	11829	Throat Plate, 38 needle hole, for needle sizes 23 and 24, in gauges from $\frac{1}{16}$ to $\frac{1}{8}$ in., in steps of $\frac{1}{16}$ in., for 211976 .....
211980	11829	Throat Plate, 35 needle hole, for needle sizes 25 and 26, in gauges $\frac{1}{16}$ , $\frac{3}{16}$ and $\frac{1}{8}$ in., for 211976 .....
212025	14321	Throat Plate, 46 needle hole, for needle sizes 16 and 18, in gauges from $\frac{1}{16}$ to $\frac{1}{8}$ in., in steps of $\frac{1}{16}$ in., for 211623 and 211624 .....
212026	14321	Throat Plate, 40 needle hole, for needle sizes 20 and 22, in gauges from $\frac{1}{16}$ to $\frac{1}{8}$ in., in steps of $\frac{1}{16}$ in., for 211623 and 211624 .....
212240	14321	Throat Plate, 40 needle hole, for needle sizes 20 and 22, in gauges $\frac{1}{16}$ , $\frac{3}{16}$ , $\frac{1}{8}$ and $\frac{3}{8}$ in., for 212241 ..
212242	14321	Throat Plate, 40 needle hole, for needle sizes 20 and 22, in $\frac{3}{8}$ in. gauge, for 231516 .....
212244	11829	Throat Plate, 40 needle hole, for needle sizes 20 and 22, in gauges from $\frac{1}{16}$ to $\frac{1}{8}$ in., in steps of $\frac{1}{16}$ in., for 212246 .....
212245	11829	Throat Plate, 46 needle hole, for needle sizes 16 and 18, in gauges from $\frac{1}{16}$ to $\frac{1}{8}$ in., in steps of $\frac{1}{16}$ in., for 212246 .....

No.	Plate	Name
212824	14322	Throat Plate, 40 needle hole, for needle sizes 20 and 22, in $\frac{1}{8}$ in. gauge, for 212825 .....
222228	14322	Throat Plate, 38 needle hole, for needle sizes 23 and 24, in gauges $\frac{3}{16}$ , $\frac{7}{32}$ and $\frac{1}{2}$ in., for 222227 .....
222240	14321	Throat Plate, 35 needle hole, for needle sizes 25 and 26, in gauges from $\frac{3}{16}$ to $\frac{15}{32}$ in., in steps of $\frac{1}{32}$ in., for 211976 .....
222289	14322	Throat Plate, 50 needle hole, for needle sizes 14 and 15, in gauges $\frac{3}{16}$ and $\frac{7}{32}$ in., for 222288 .....
222290	14322	Throat Plate, 46 needle hole, for needle sizes 16 and 18, in gauges $\frac{3}{16}$ and $\frac{7}{32}$ in., for 222288 .....
222291	14322	Throat Plate, 40 needle hole, for needle sizes 20 and 22, in gauges $\frac{3}{16}$ and $\frac{7}{32}$ in., for 222288 .....

## OBSOLETE PARTS

No.	Plate	Name
202470	12320	Bobbin Winder Base .....
202471	12320	" " Frame .....
202472	12319	" " " Spring .....
202474	12320	" " Spindle .....
202477	12319	" " Stop Latch Thumb Lever .....
202480	12320	Bobbin Winder Spool Holder Base with 200355u and 202484 .....
202481	12320	Bobbin Winder Spool Holder Base Spool Pin .....
202482	12319	Bobbin Winder Spool Holder Tension Disc (lower or upper) .....
202483	12319	Bobbin Winder Spool Holder Tension Disc Spring (brass) .....
202484	12319	Bobbin Winder Spool Holder Tension Disc Thread Guide .....
202485	12320	Bobbin Winder Spool Holder complete, Nos. 200011e, 202480, 202481, 202483, two 202482 and one wood screw $\frac{1}{2}$ in., No. 12 ..
227522	12319	Bobbin Winder Stop Latch .....
227523	12320	Bobbin Winder complete, Nos. 200056e, 200161d, 200221b, 201537u, 202470 to 202474, 204277, 204278, 227522, three 200299u and two round head wood screws $\frac{3}{4}$ in., No. 12 .....
213110	14324	Face Plate with 200366u, 202087, 204185, 204730, two each 202090, 204281, three each 200368u and 200297u, for 213111 .....
213111	----	Face Plate complete, Nos. 200577u, 204731, 204795, 213110, two each 204059 and 206639, for Machine No. 22w206 .....
*213605	----	Feed Driving Cam Fork Lever Slide Block .....
*213604	----	Feed Driving Cam Fork Lever Slide Block with 200116c .....
213606	11897	Feed Driving Cam Fork Lever Slide Block 213604 with 213605 .....
203250	11007	Hook Driving Shaft Collar with two 200393c .....

PLATE 10483—FULL SIZE

INSTRUCTIONS OF PARTS  
FOR  
MACHINES  
304-33, 38W33, 38W34, 38W35  
38W36, 38W37, 38W38  
38W39

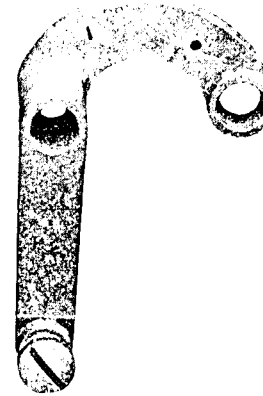
200181



202088



204475



200309



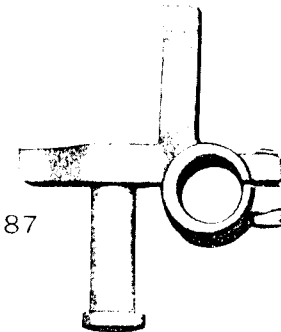
200122



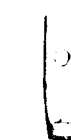
200188



204480



200685



200587



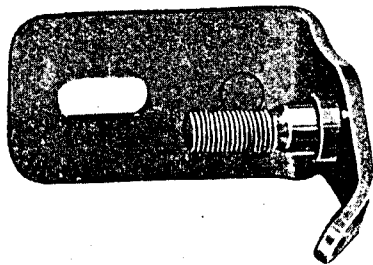
204478



From the library of: Diamond Needle Corp

PLATE 10881—FULL SIZE

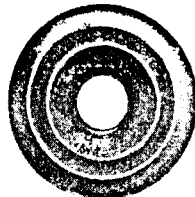
225461



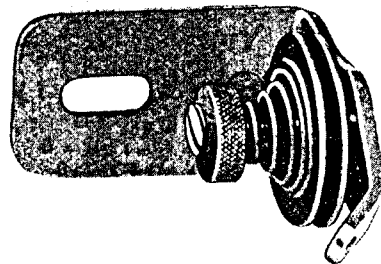
200082 202104



2102



225462



202407



201499

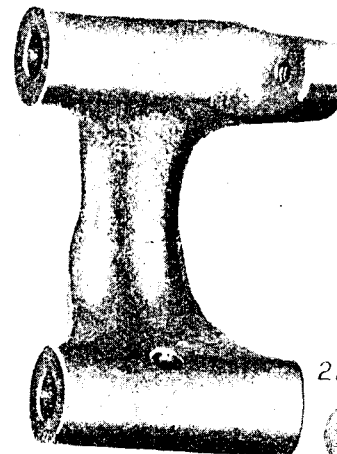


201572

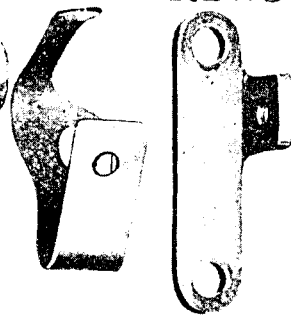


PLATE 10884—FULL SIZE

225453



225444 202478



228026

225458



225460

225454

200299



200056

225438

225459

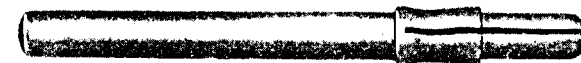
225456



200105



225381



225455

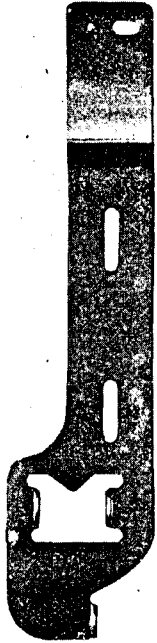


From the Library of Diamond Needle Corp



PLATE 10885—ONE-FOURTH SIZE

225433



202473

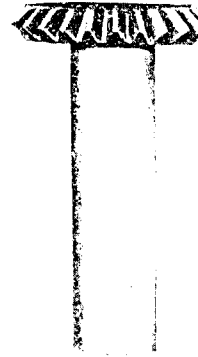


225382



PLATE 11007—FULL SIZE

203241



200555



203242



203245



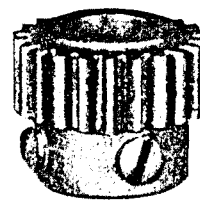
203250



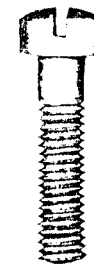
200393

EM

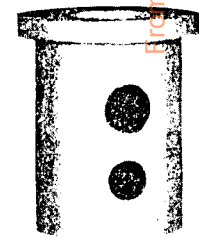
203246



200006



203249



225585



203244



200840

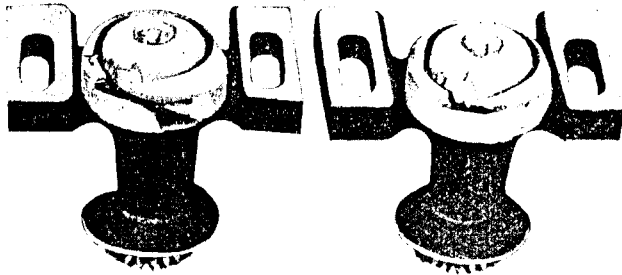


From the library of: David and Mercedes

PLATE 11242—ONE HALF SIZE

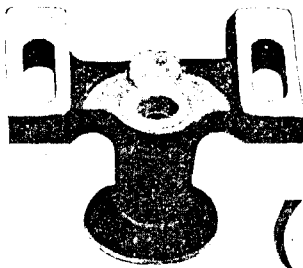
203468

203468



203307

203464



203718



203718



203469

№ 4 OUTFIT

203208

203209

203210

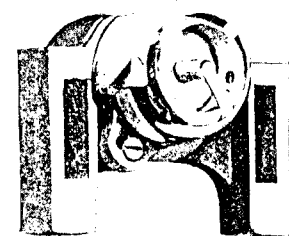
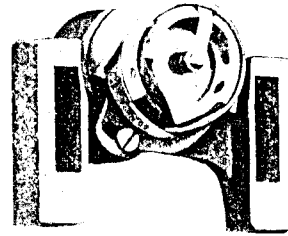
203241



PLATE 11249—ONE HALF SIZE

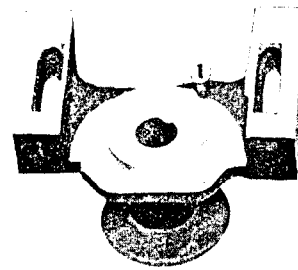
203509

203509



203508

203483



203510

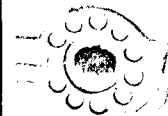
№ 8 OUTFIT

203499

213018

213018

203506



203470

203500

203478

213810



From the library of: Diamond Needle Corp

PLATE 11251—ONE-HALF SIZE

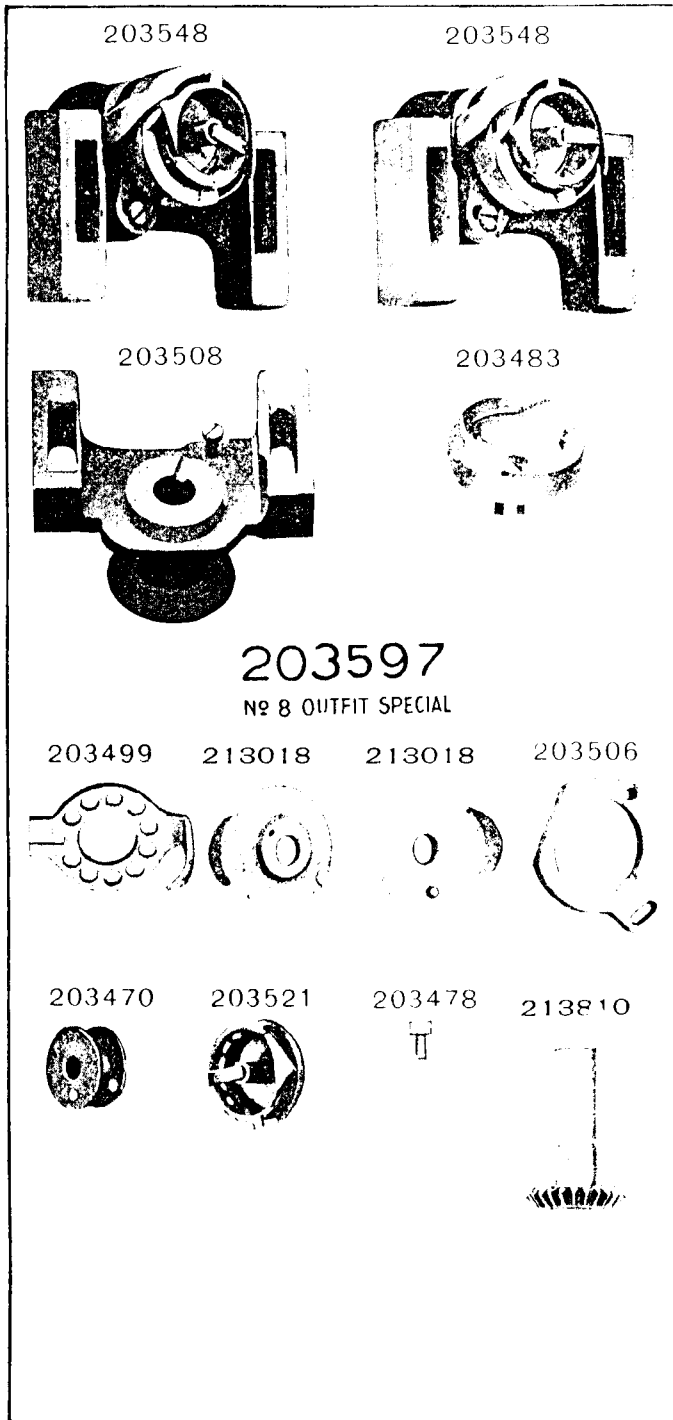
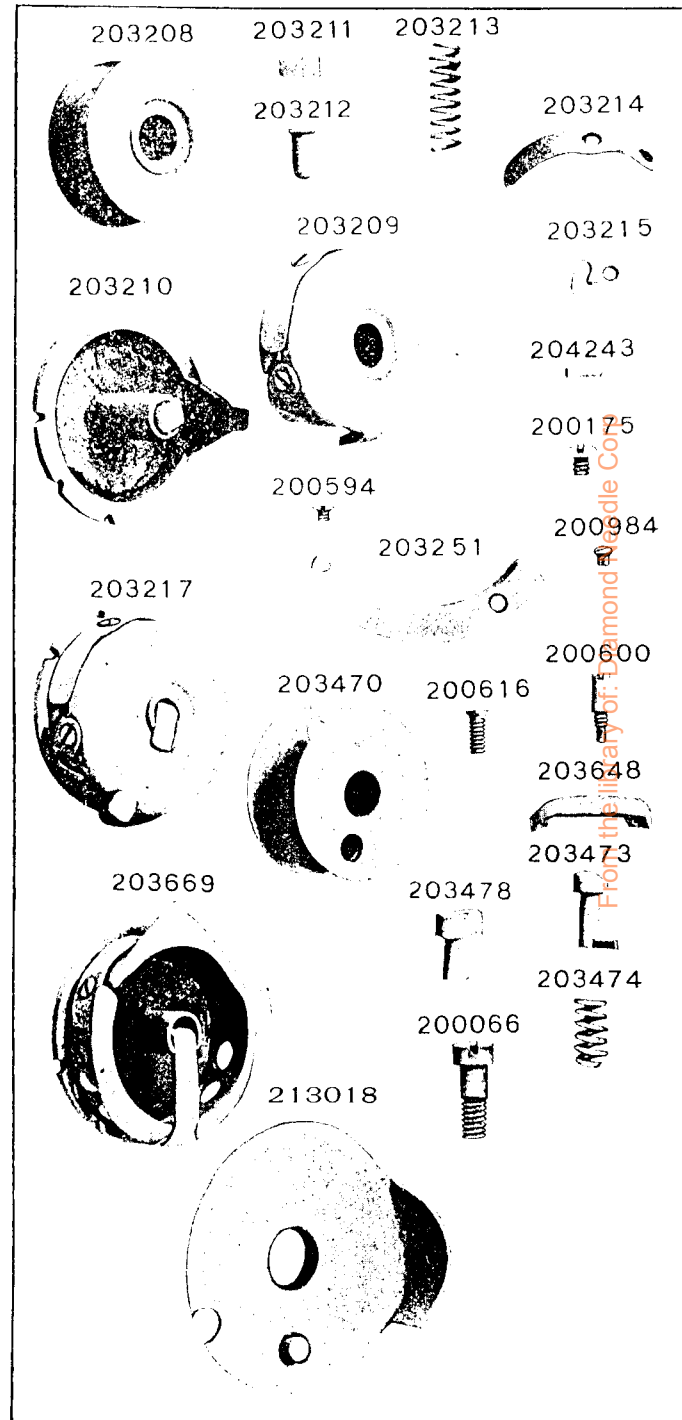


PLATE 11284—FULL SIZE



From the library of: Diamond Needle Co.

PLATE 11806 -FULL SIZE

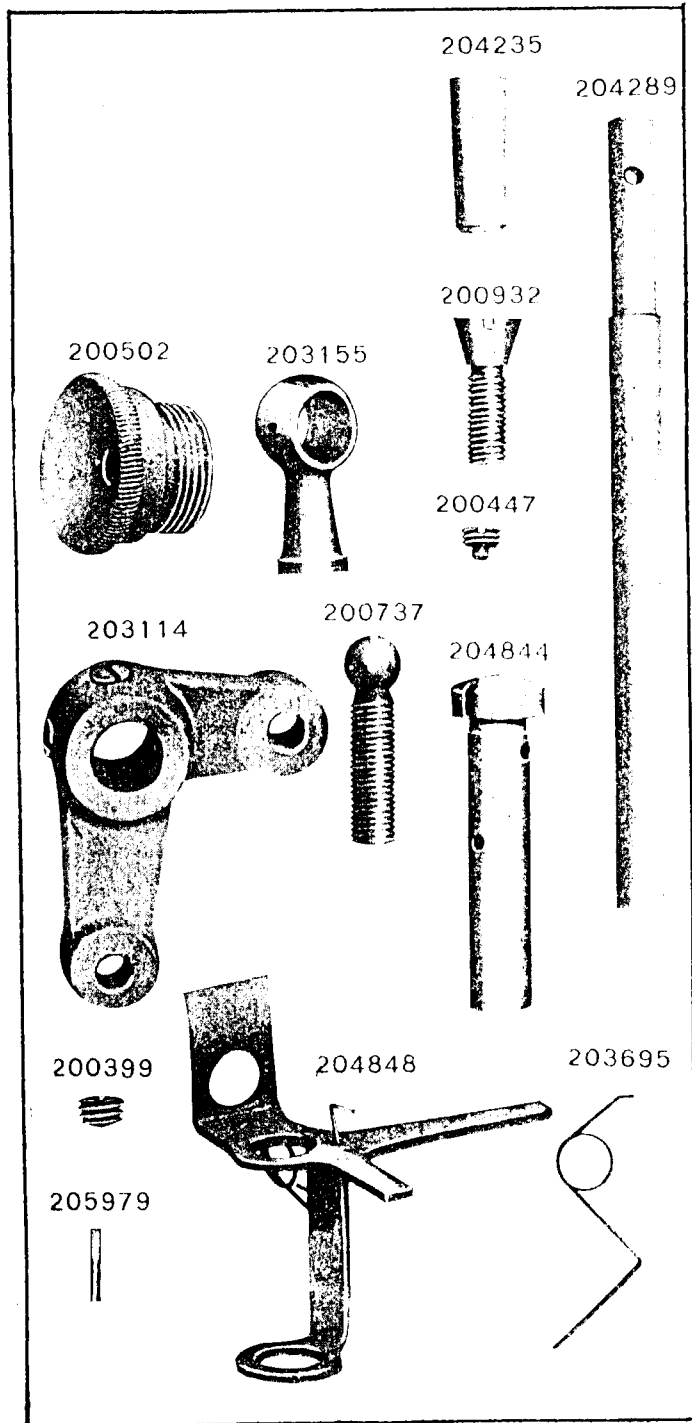


PLATE 11824 -FULL SIZE

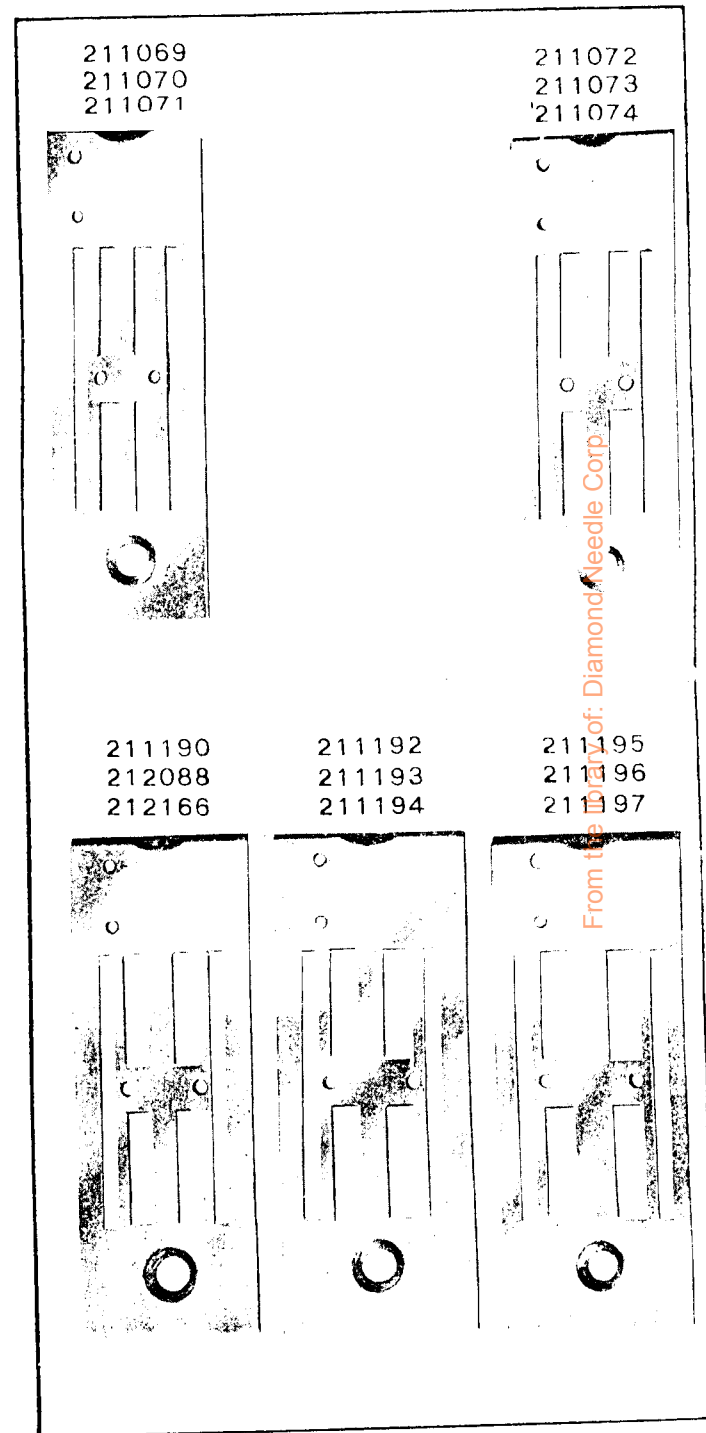
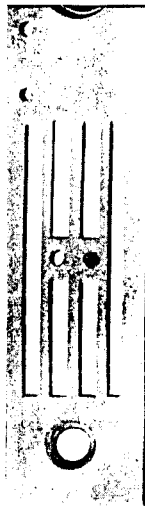


PLATE 11825 -FULL SIZE

212224



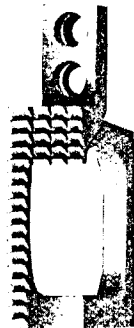
211068  
212569  
212570



212252



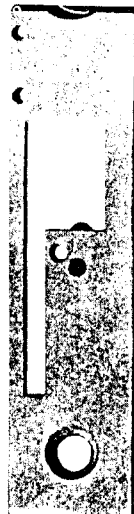
210999



212165



211049

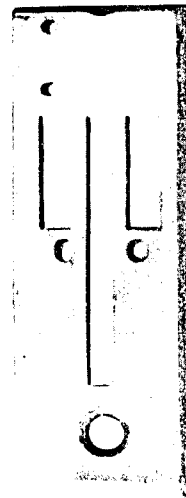


212251



PLATE 11829 -FULL SIZE

211977  
211978  
211979  
211980



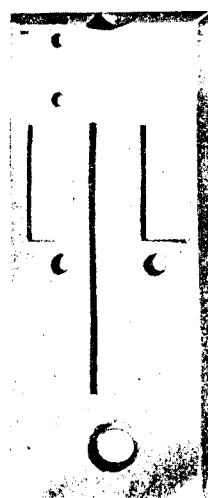
211976



211974



211975



212244  
212245



212246



From the library of <http://www.needlecorp.com>

PLATE 11832 -FULL SIZE

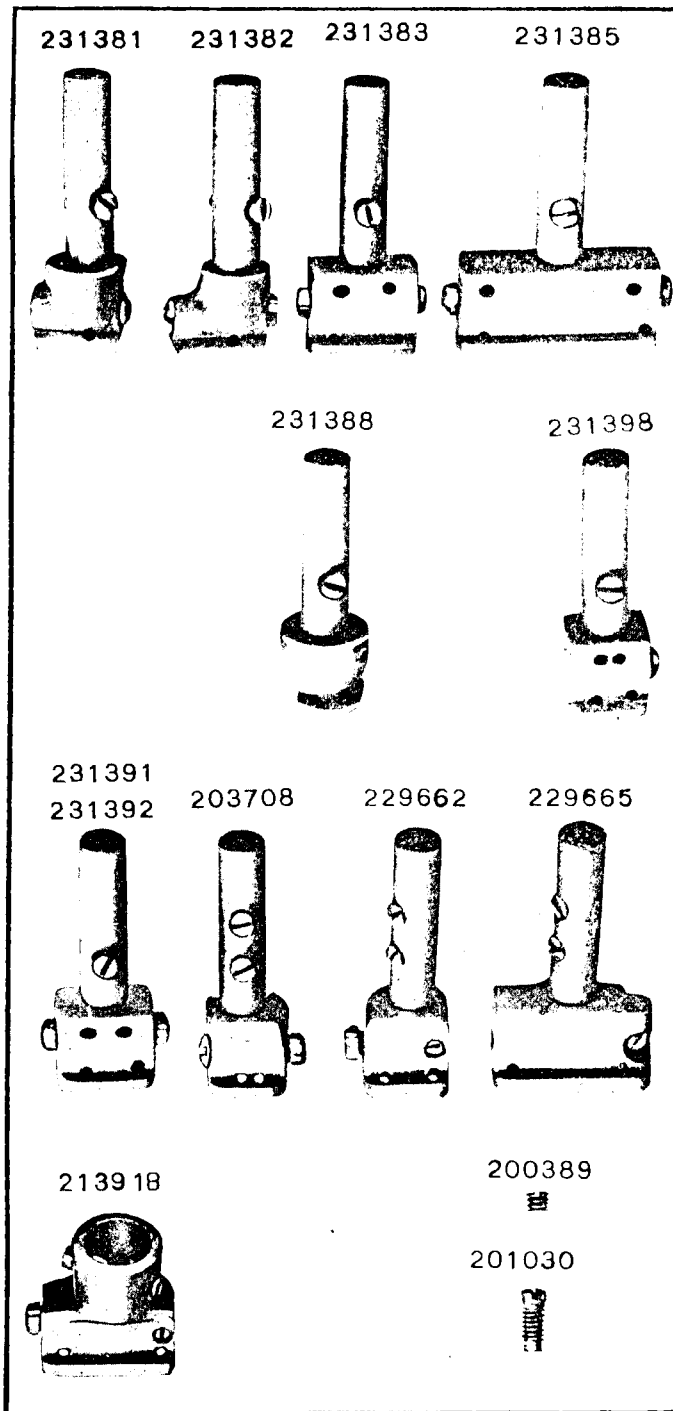


PLATE 11837 -FULL SIZE

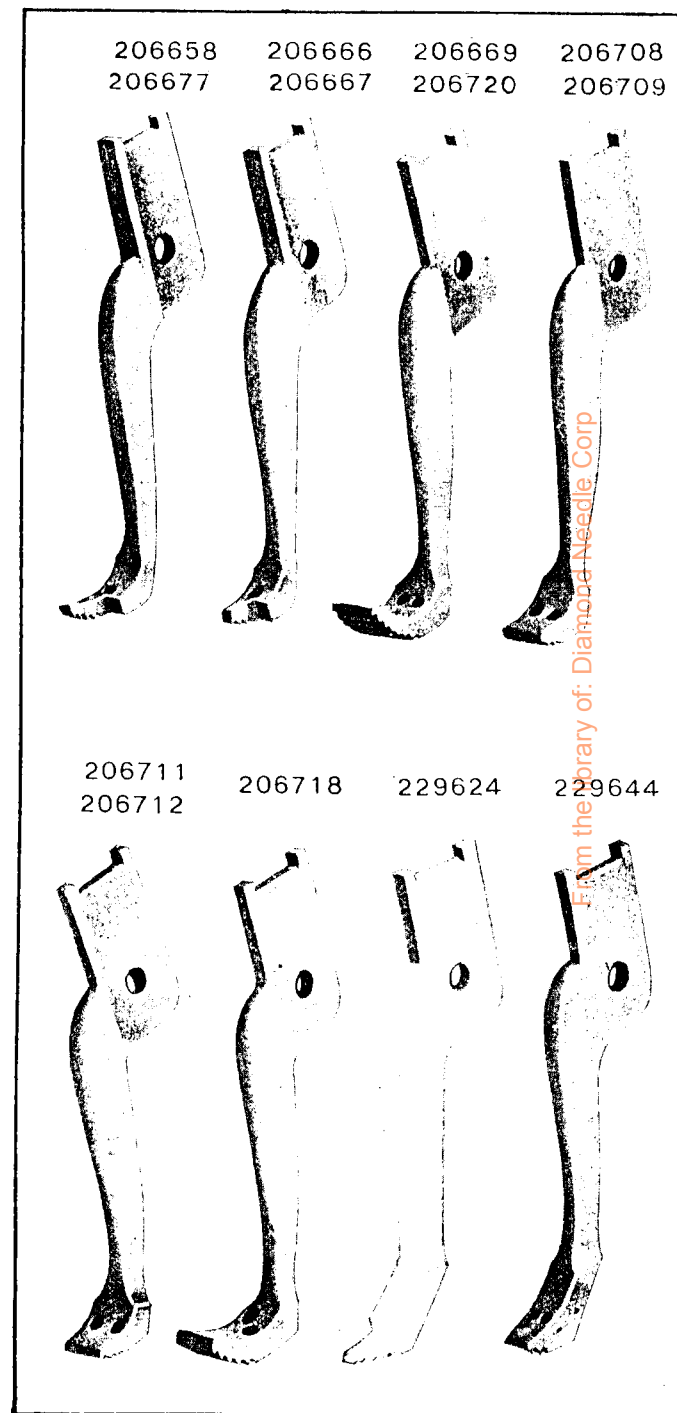


PLATE 11839 -FULL SIZE

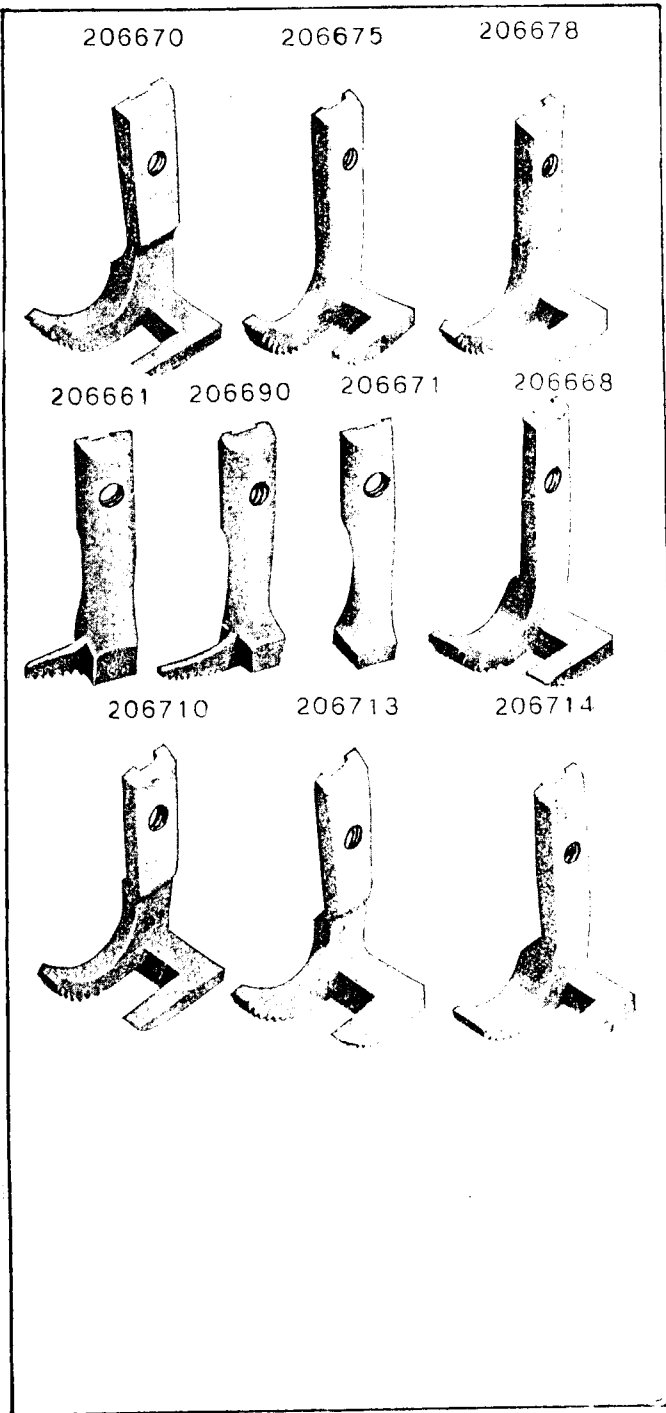


PLATE 11845 -FULL SIZE

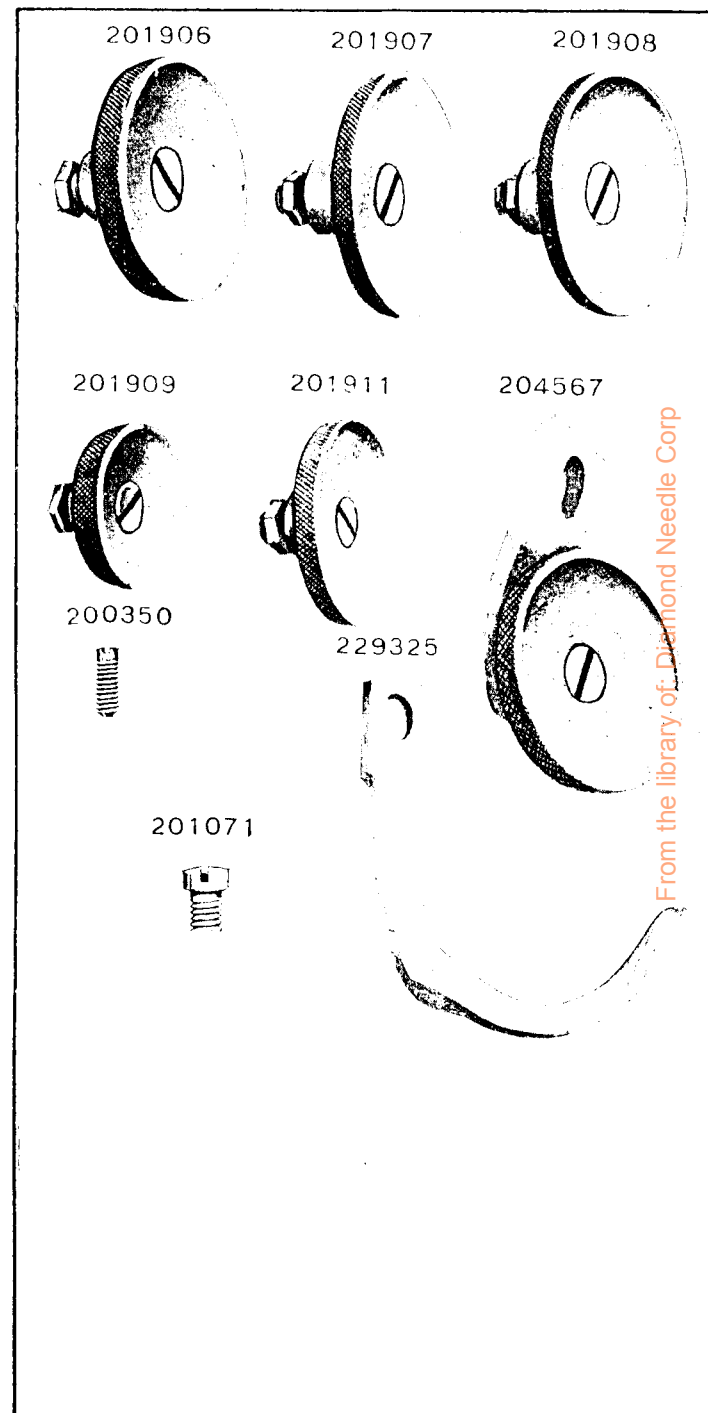


PLATE 11867 - ONE-FOURTH SIZE

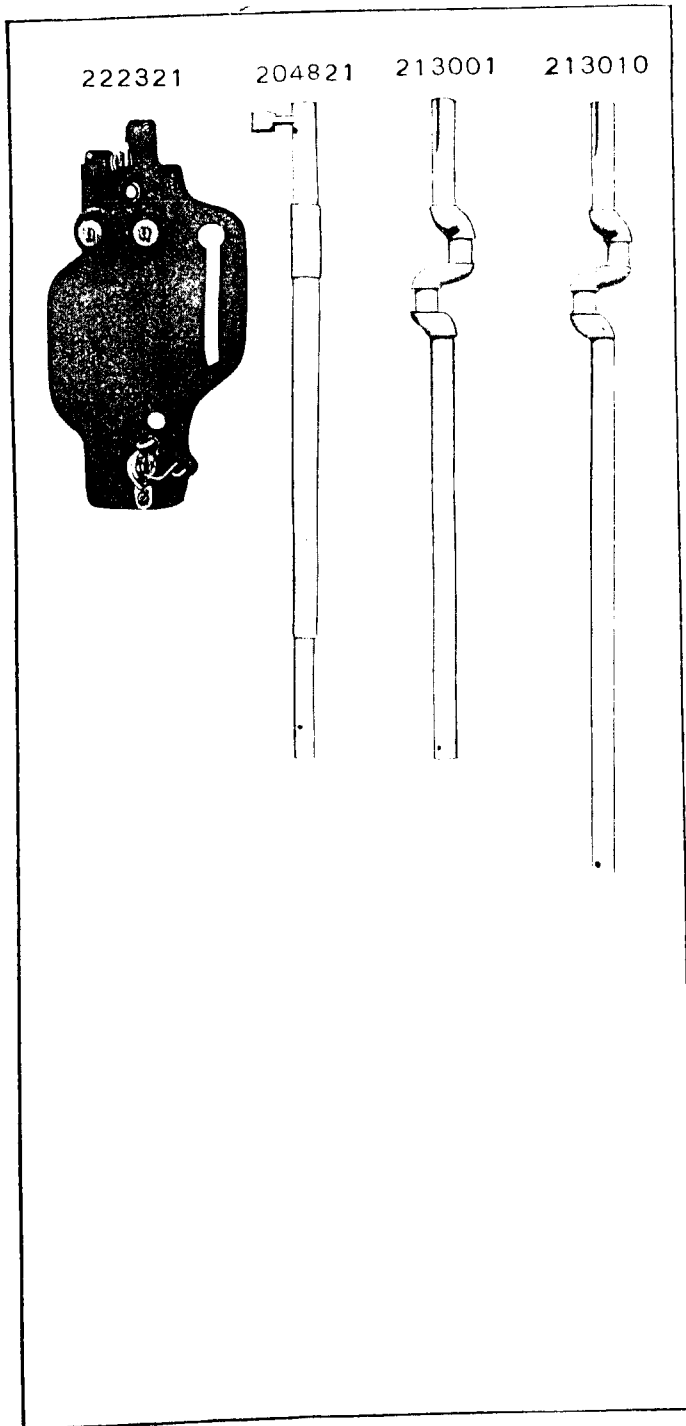


PLATE 11871 - ONE-HALF SIZE

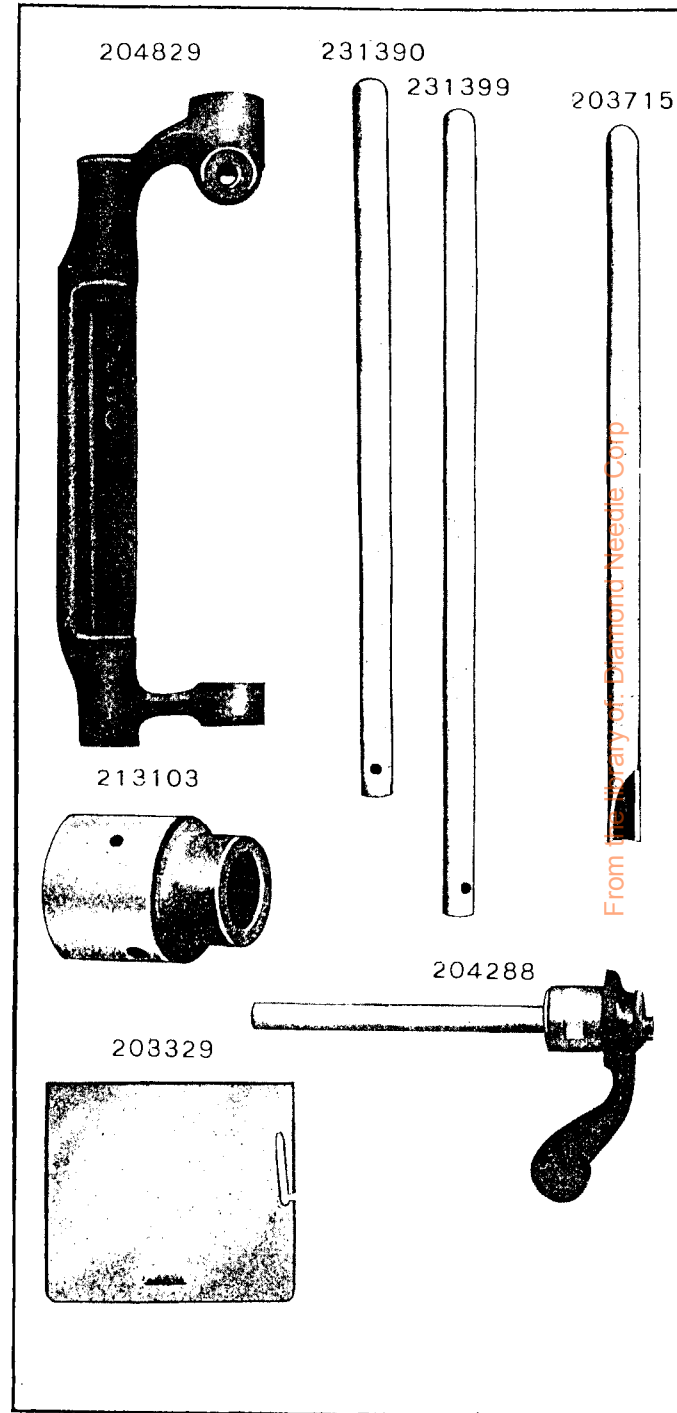




PLATE 11874-FULL SIZE

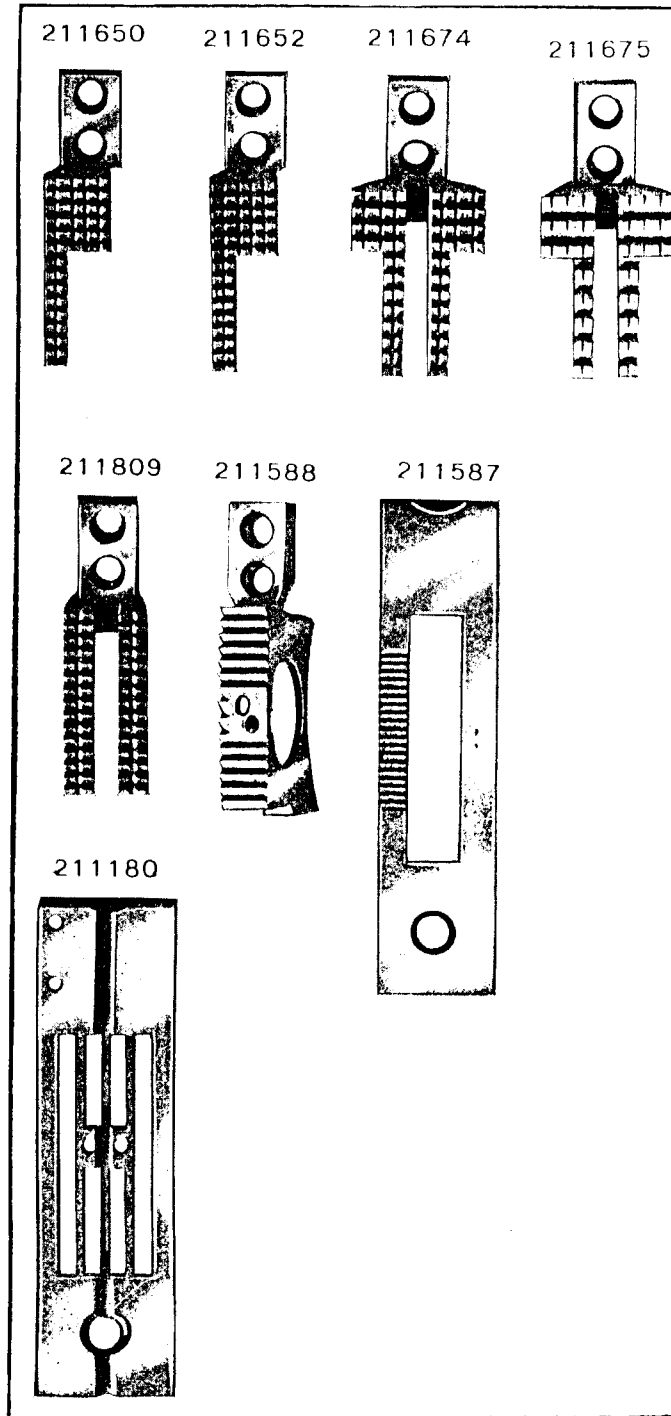


PLATE 11897-FULL SIZE

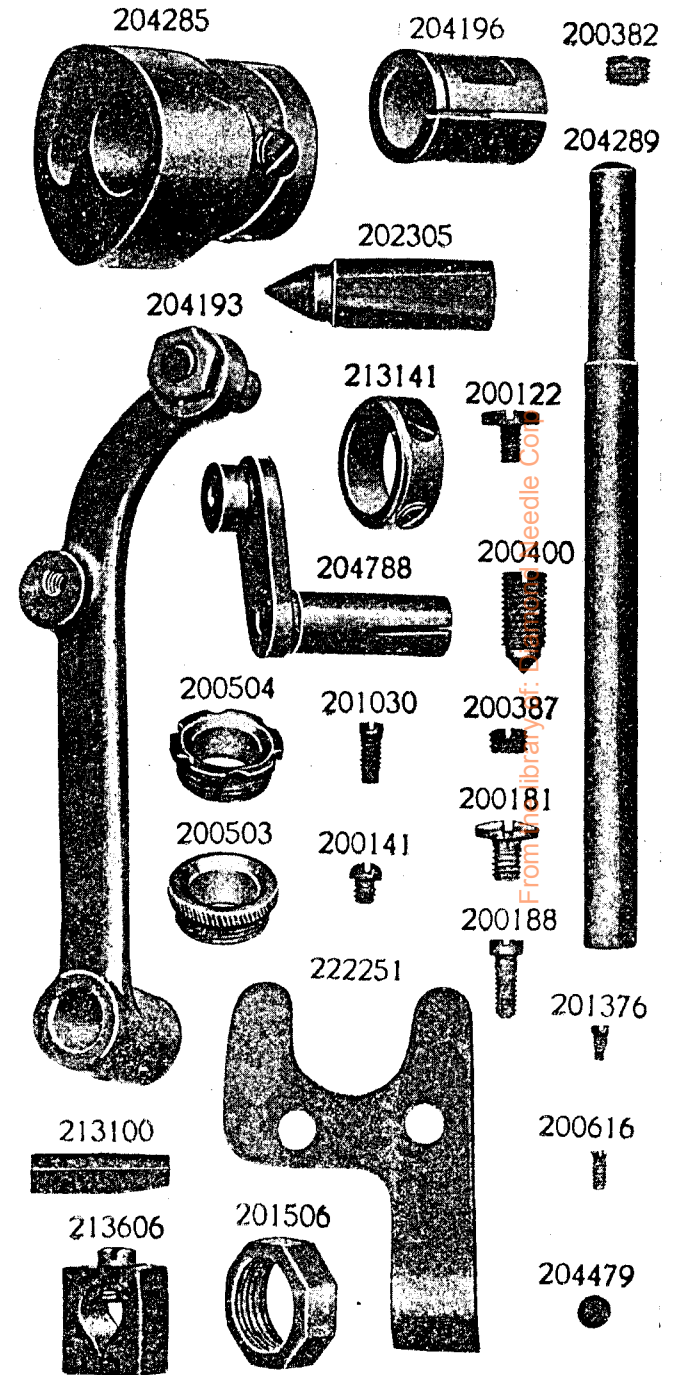
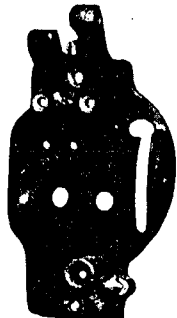


PLATE .11901—ONE-FOURTH SIZE

213746



213747

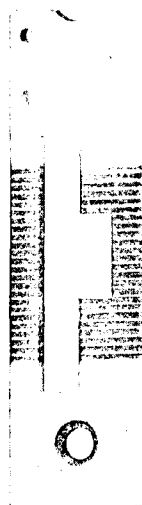


213001



PLATE 12078—FULL SIZE

211589



211296

211590

211591



From the library of: Diamond Needle Corp

PLATE 12079—FULL SIZE

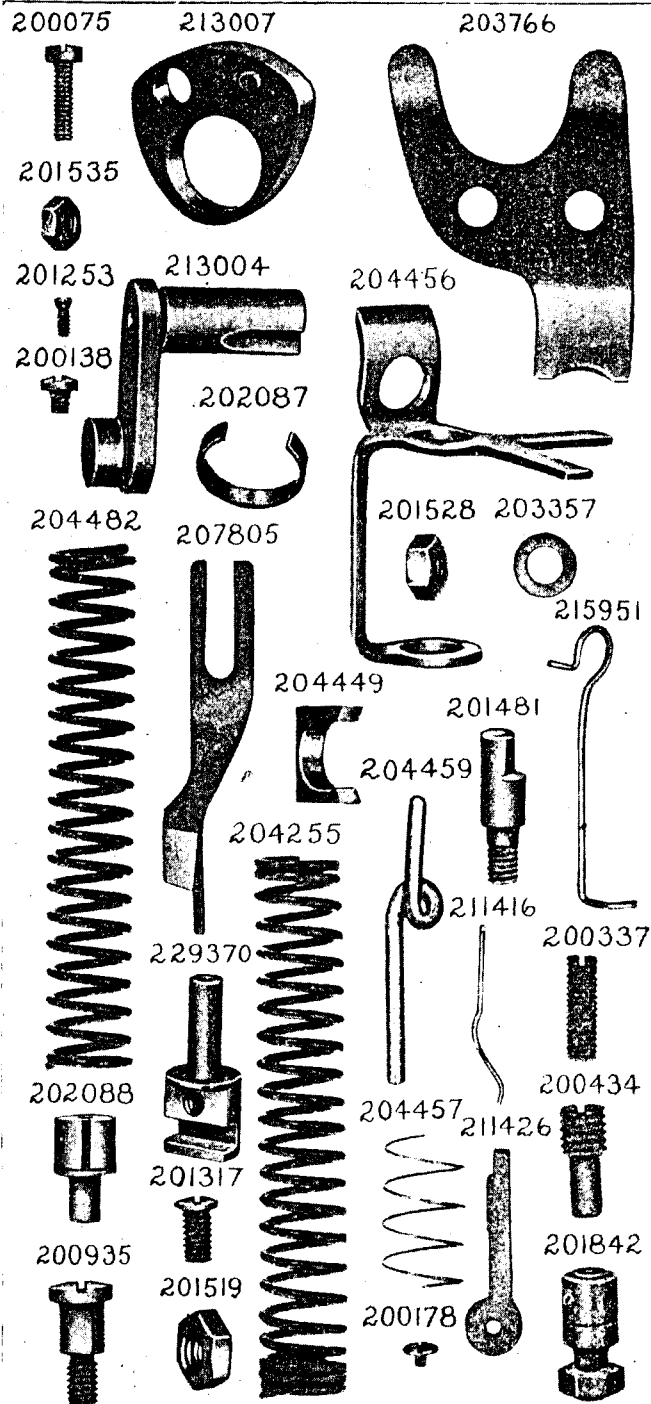


PLATE 12080—FULL SIZE

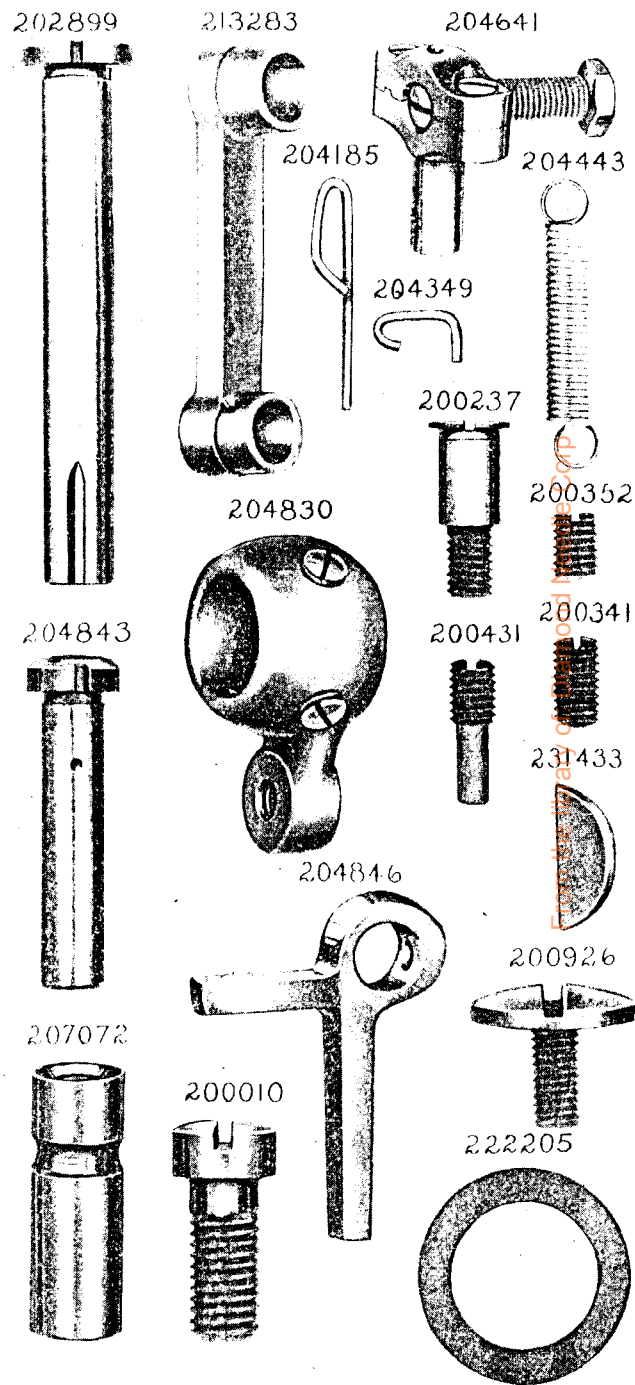


PLATE 12081—ONE-HALF SIZE

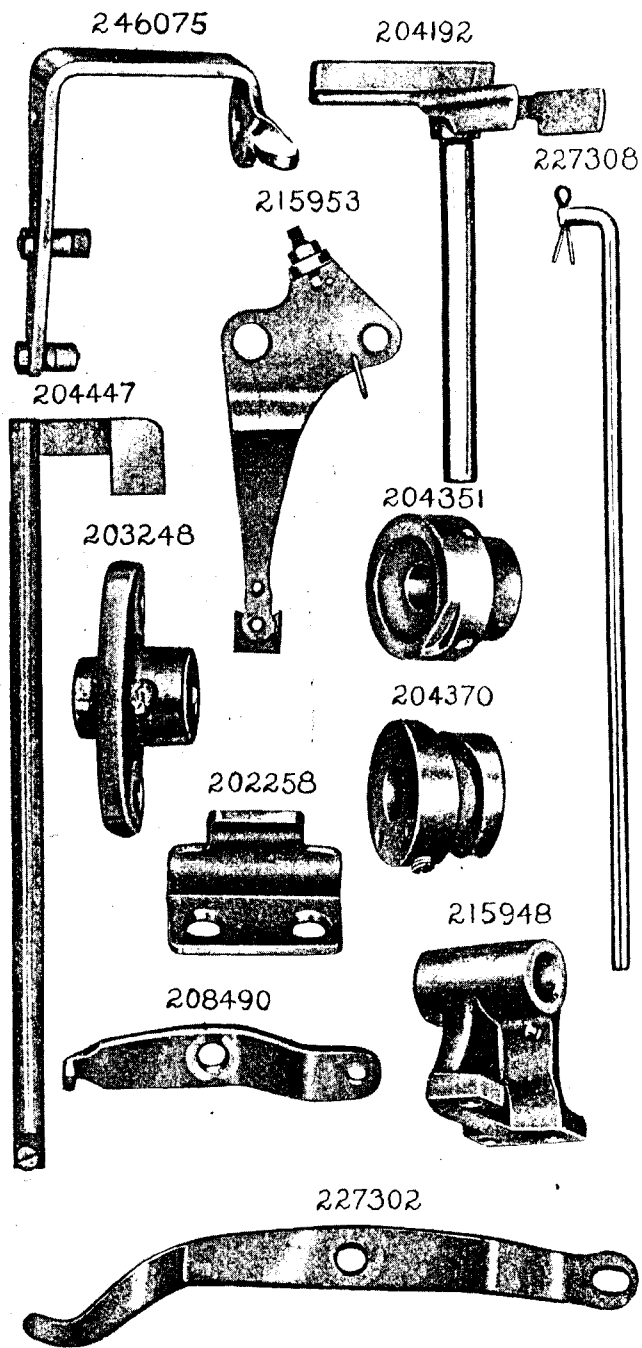
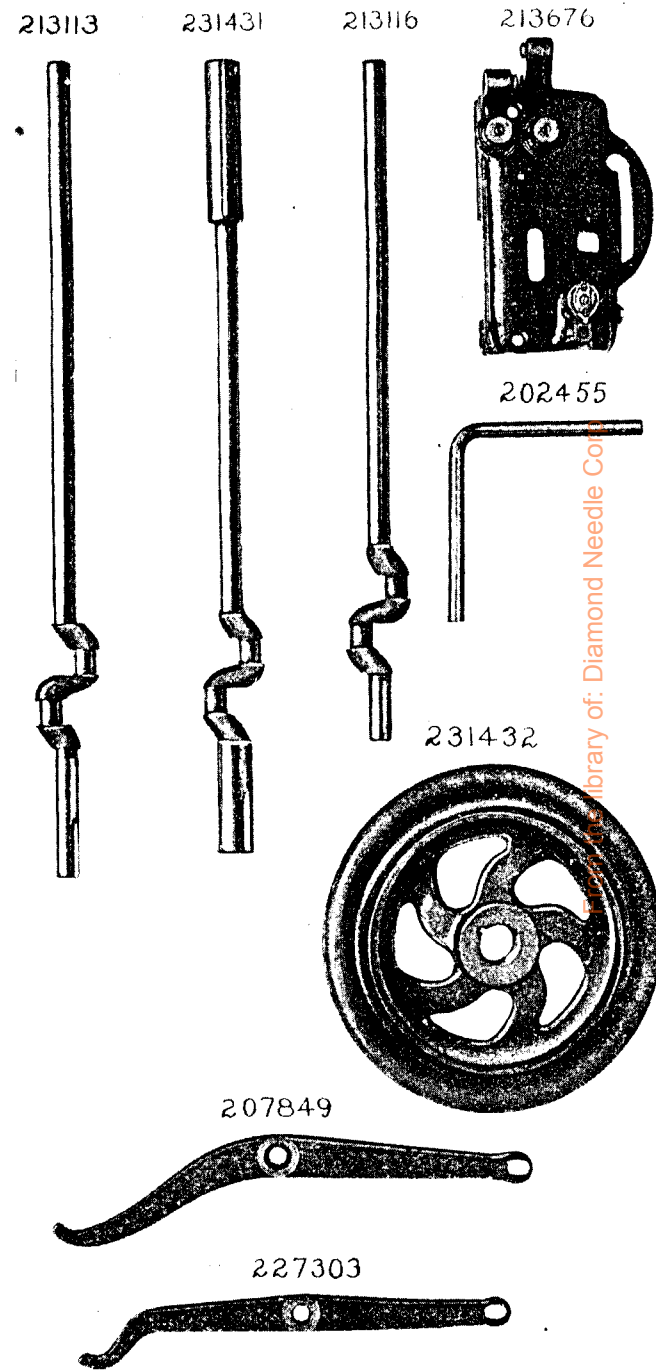


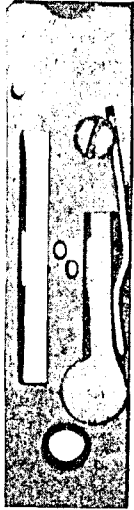
PLATE 12084—ONE-FOURTH SIZE



Library of: Diamond Needle Co

PLATE 12158—FULL SIZE

212196  
212197  
212223

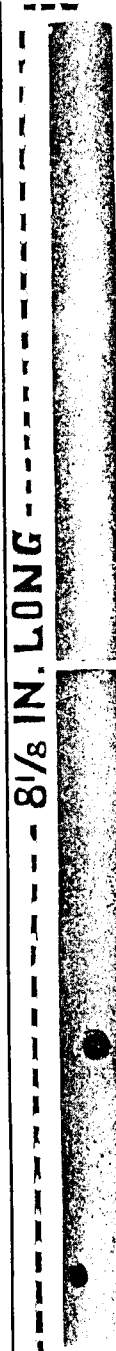


212196  
212197  
212223



PLATE 12225—FULL SIZE

204495



8 1/8 IN. LONG

200675



200551



201534



200141



200096



200113



202560



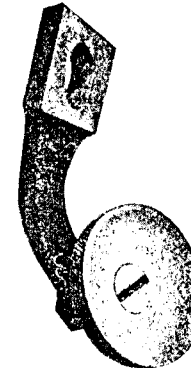
202558



201910



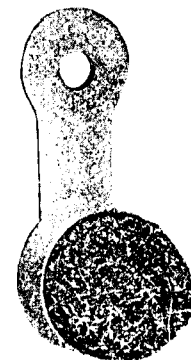
204570



202559



204330



From the library of: Diamond Needle Corp

PLATE 12305—FULL SIZE

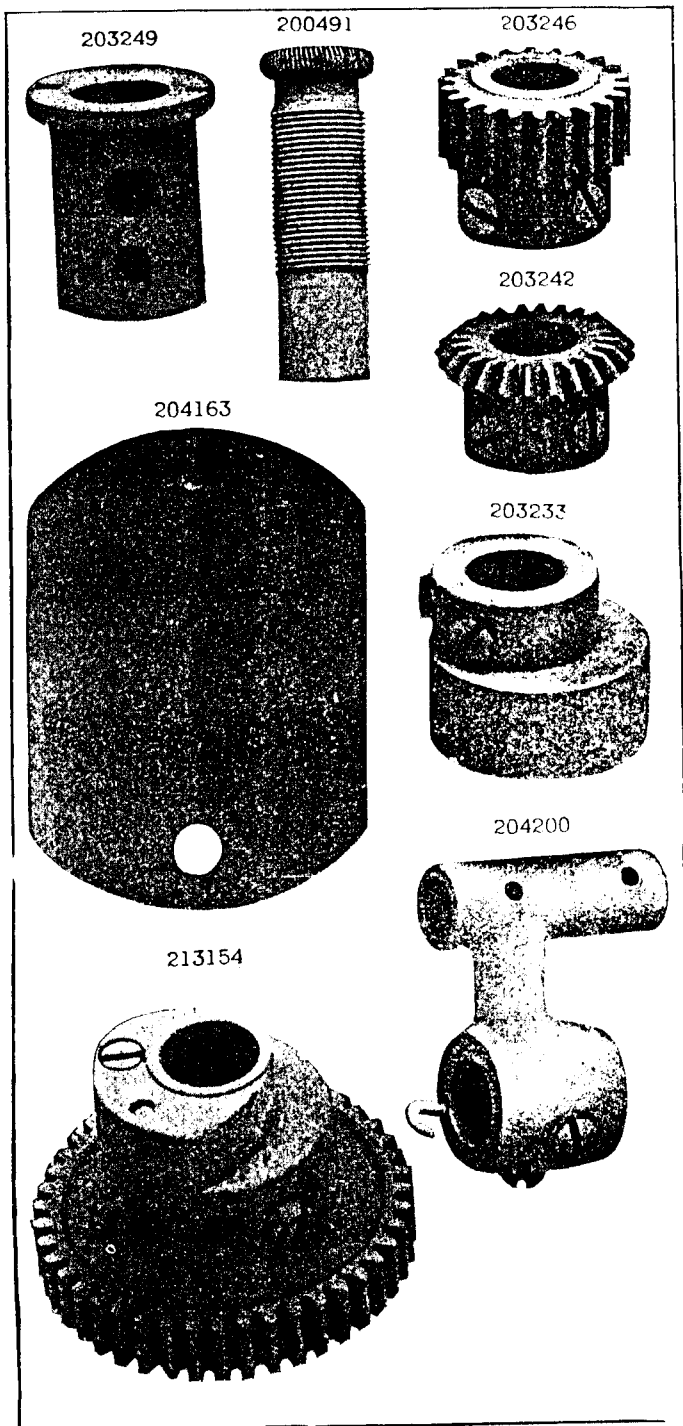
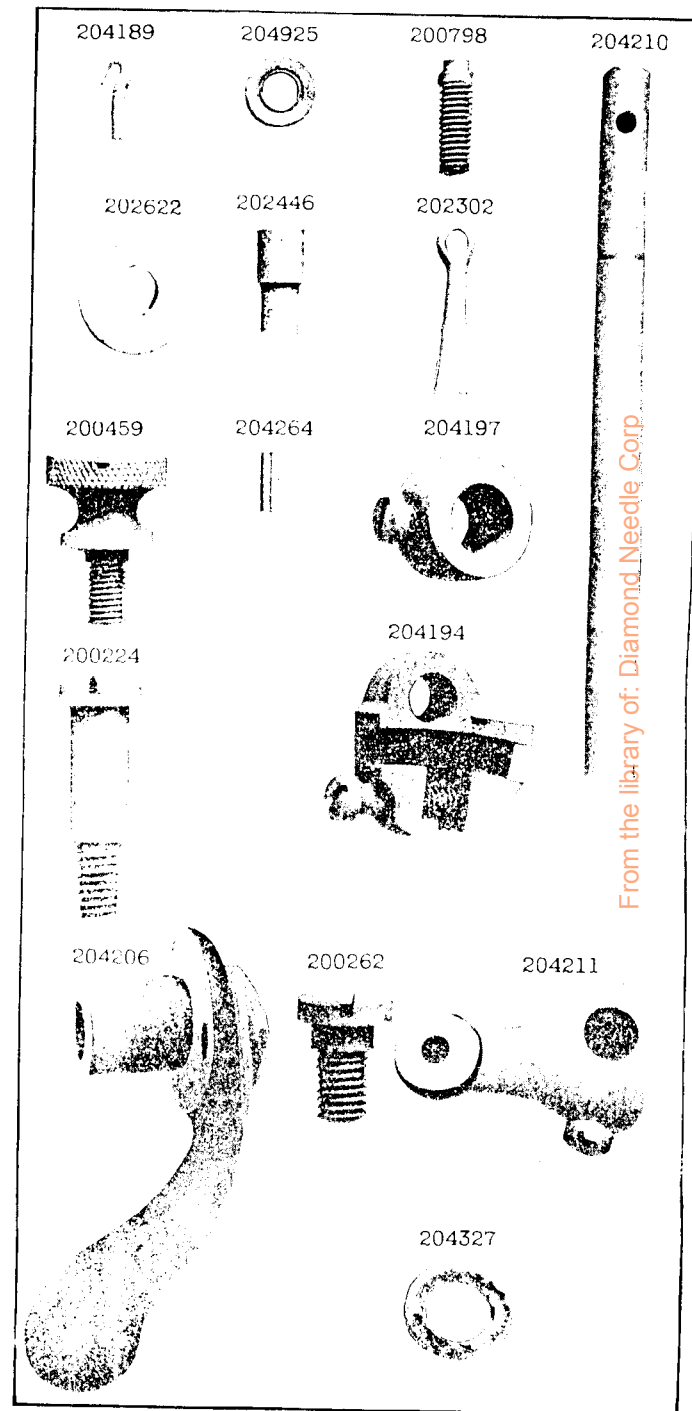


PLATE 12306—FULL SIZE



From the library of: Diamond Needle Corp.

PLATE 12307—FULL SIZE

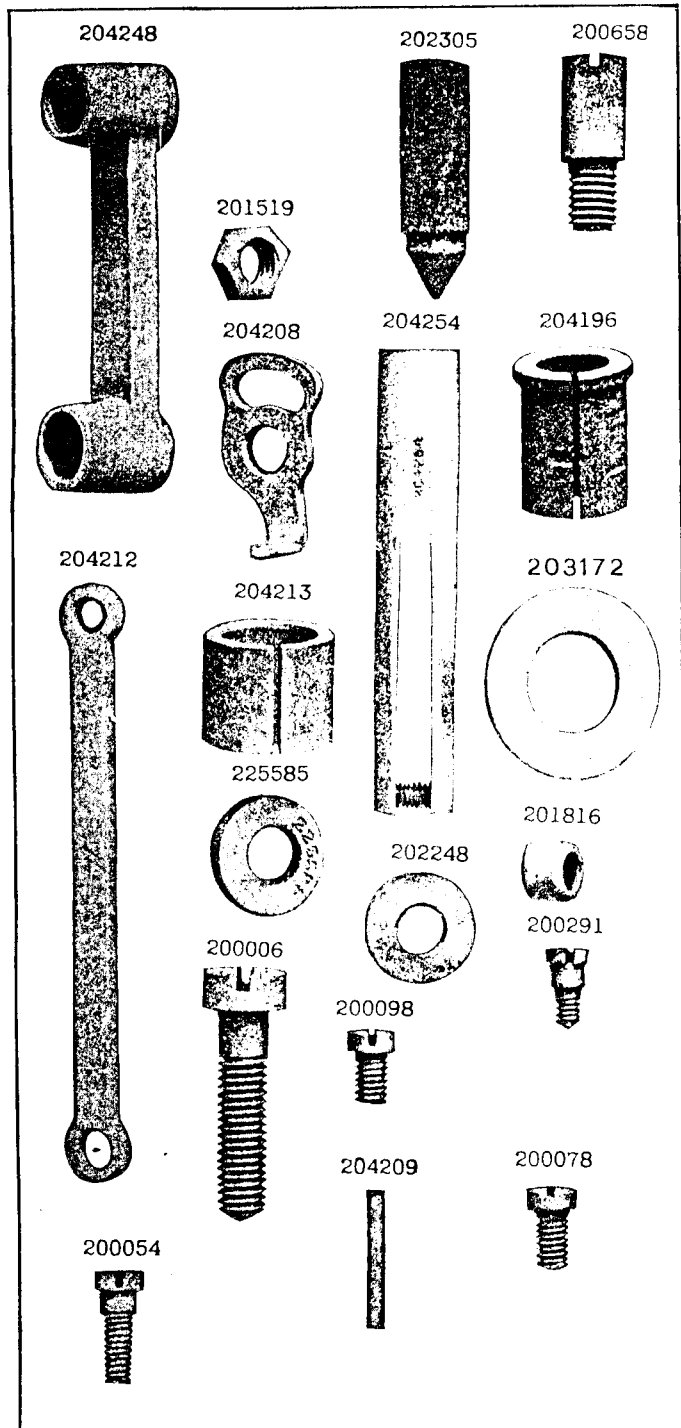


PLATE 12308—FULL SIZE

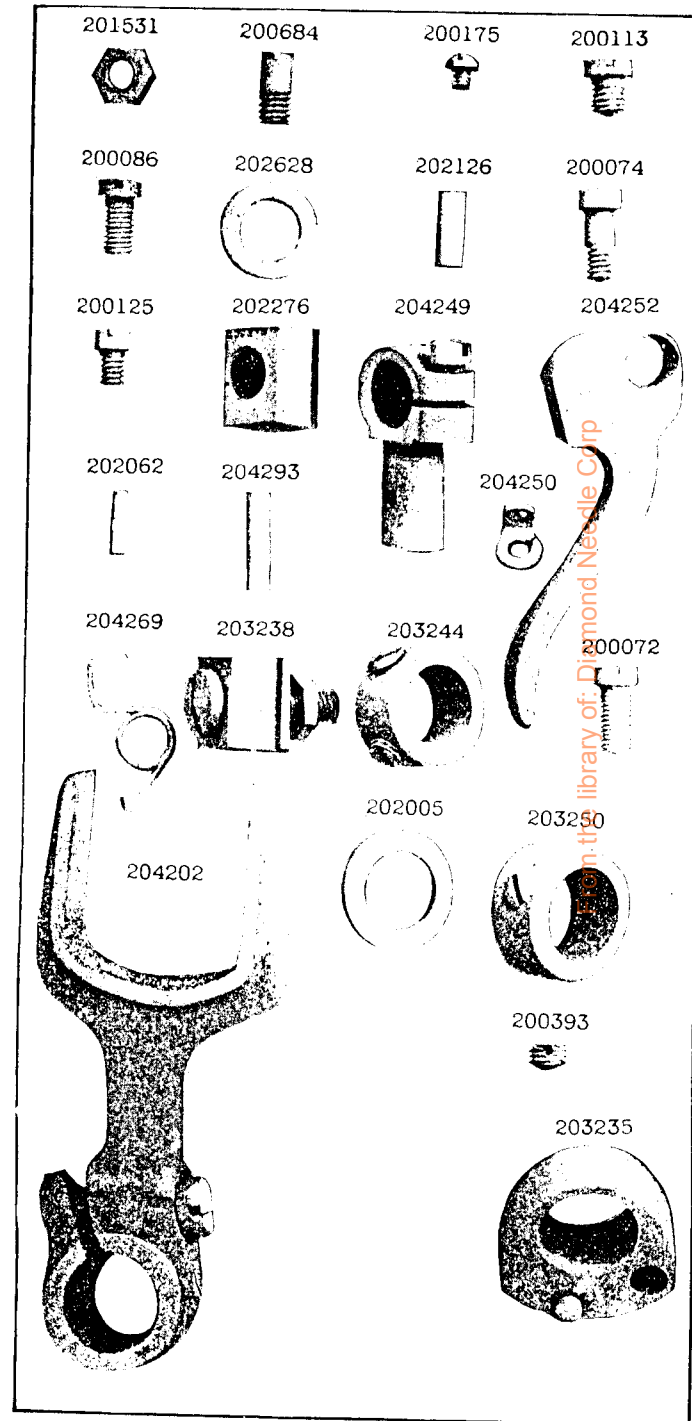


PLATE 12309 - FULL SIZE

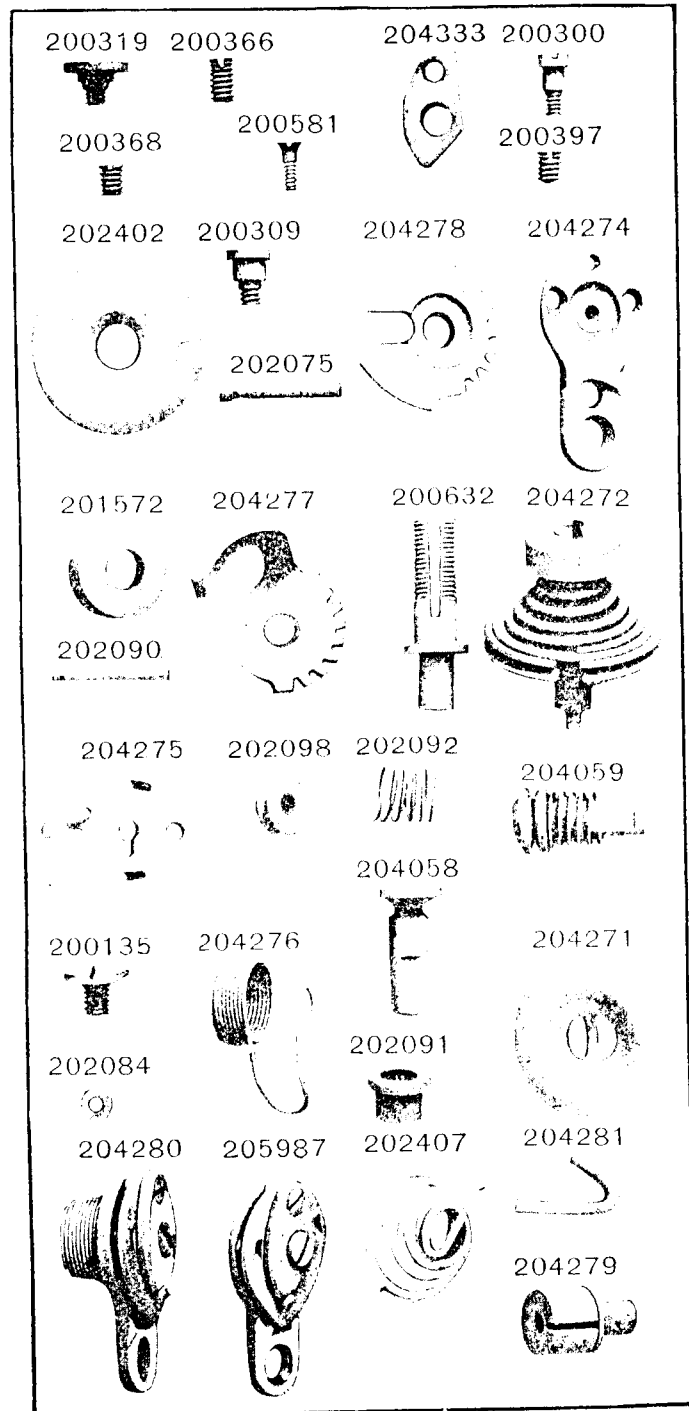


PLATE 12311 - FULL SIZE

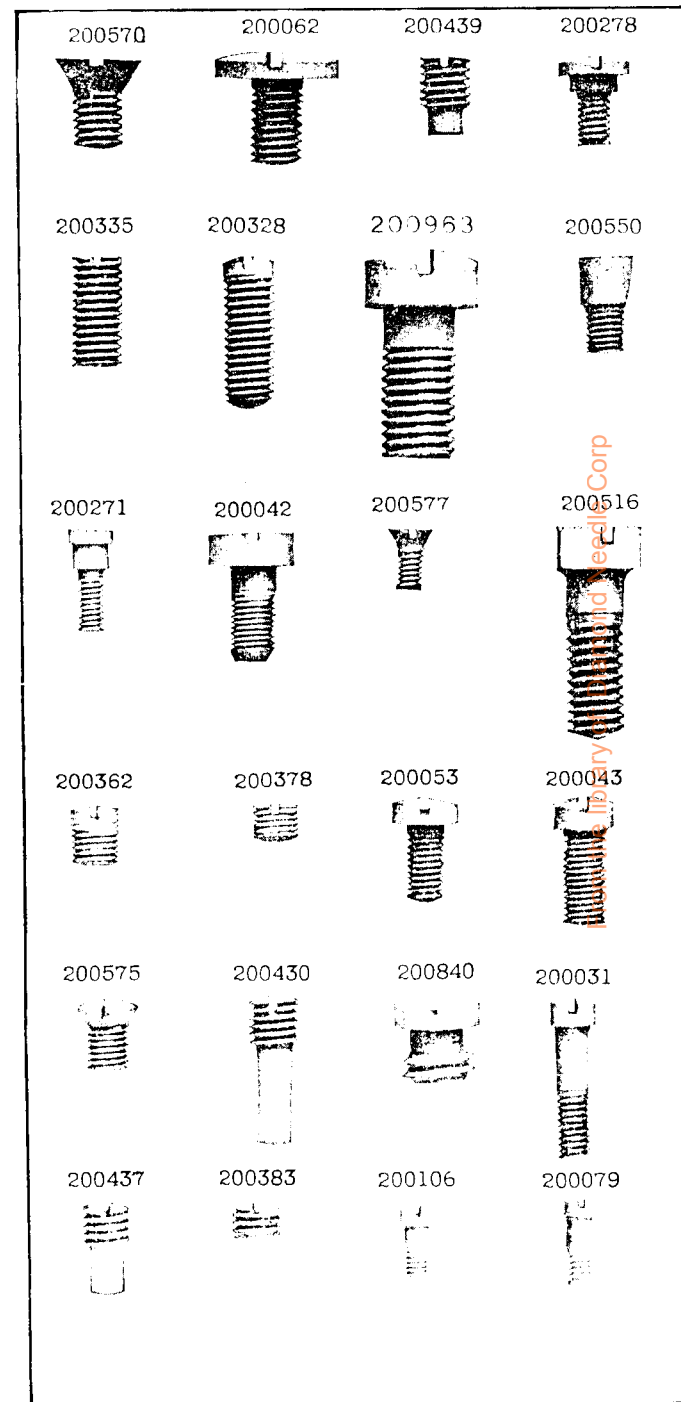




PLATE 12319 - FULL SIZE

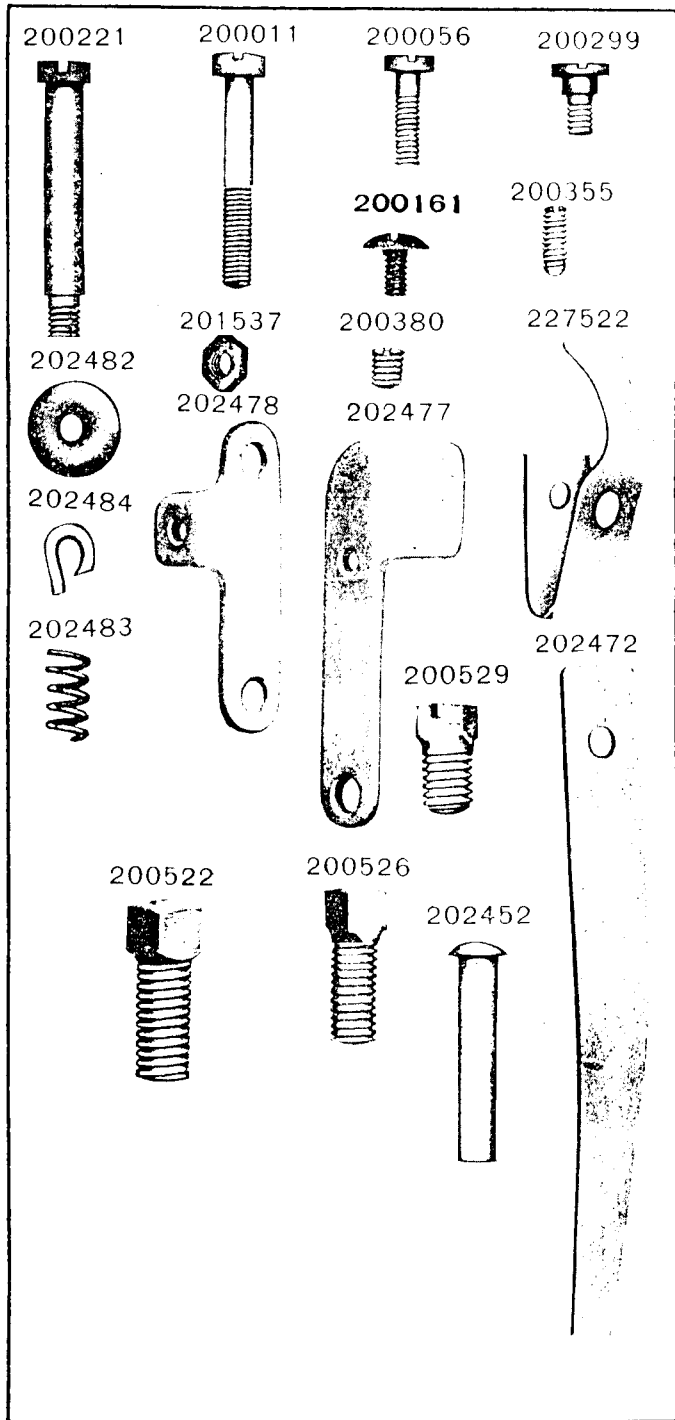


PLATE 12320 - ONE-HALF SIZE

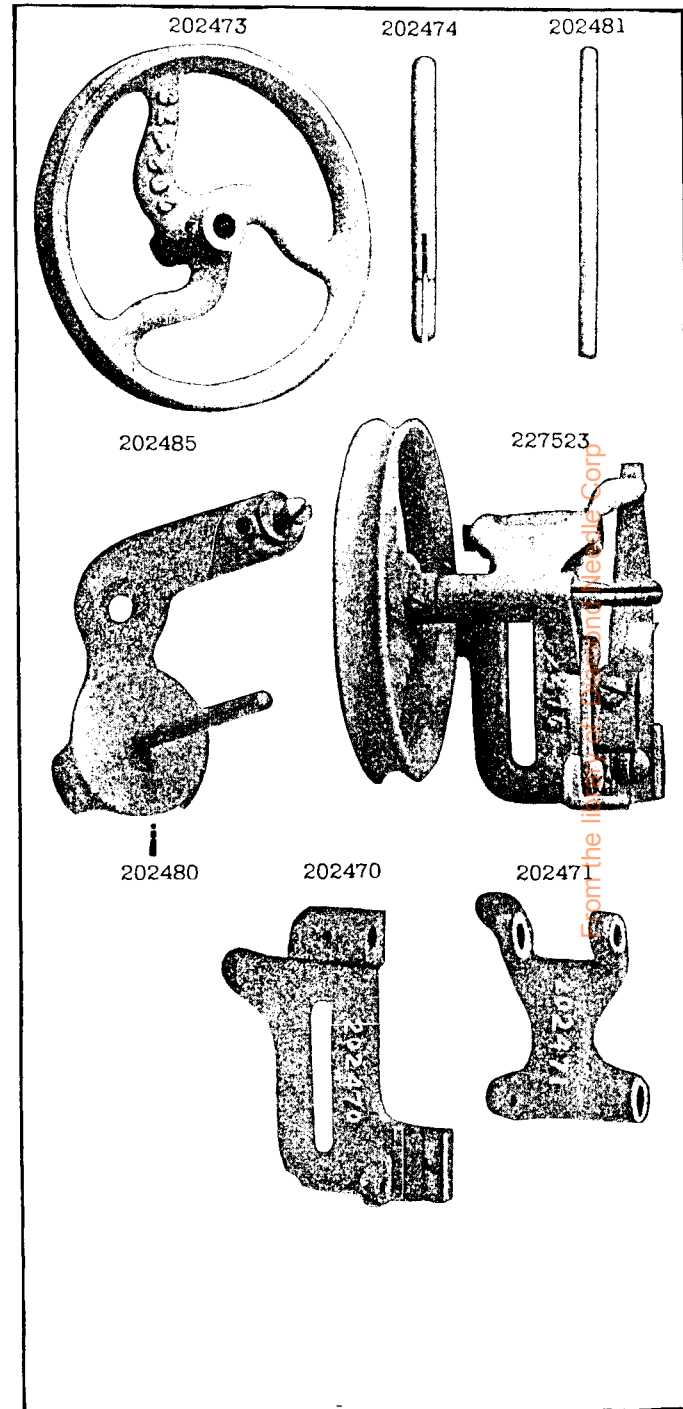


PLATE 12333—ONE-FOURTH SIZE

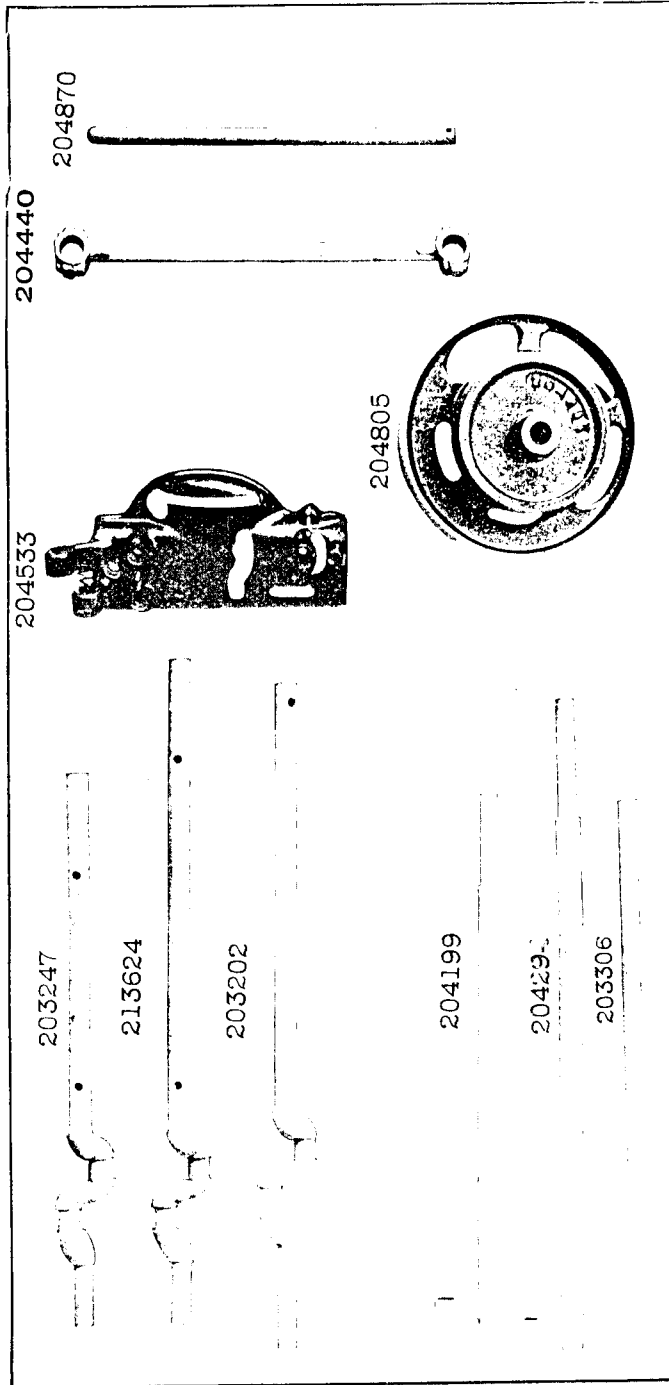


PLATE 12334—ONE-HALF SIZE

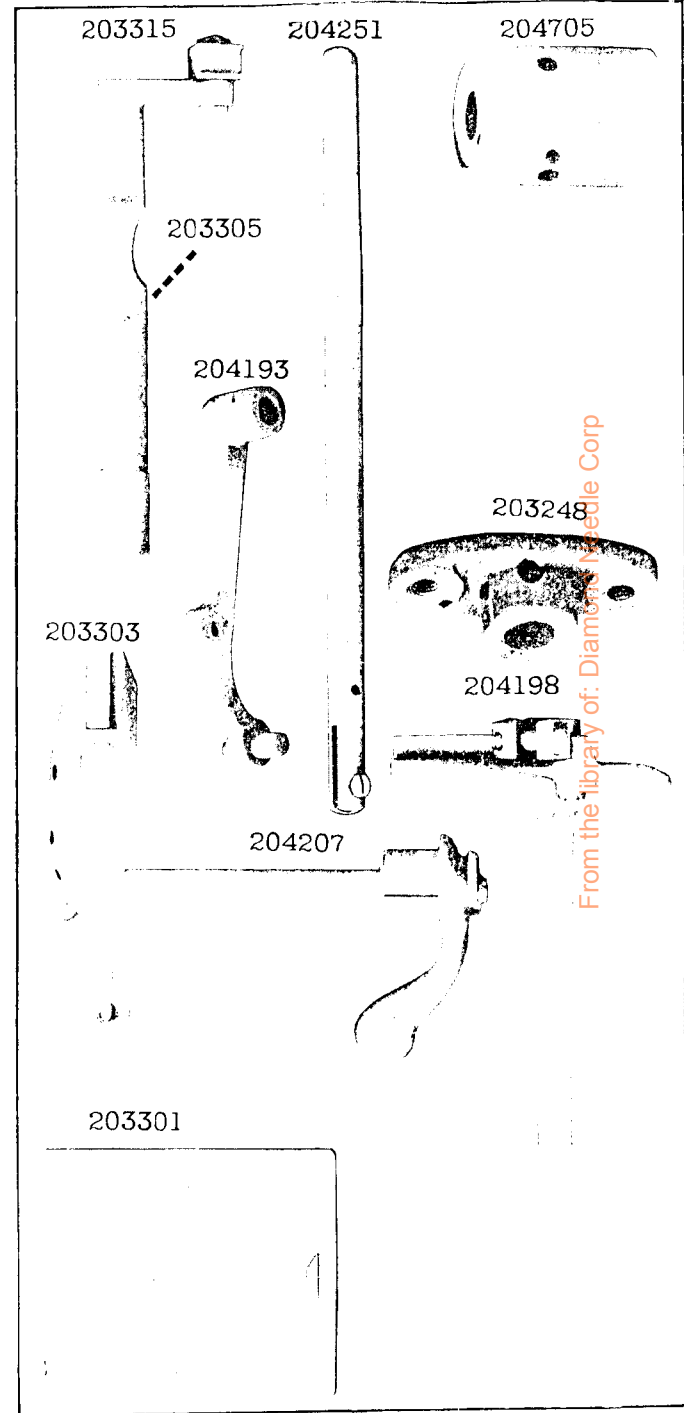


PLATE 12338—FULL SIZE

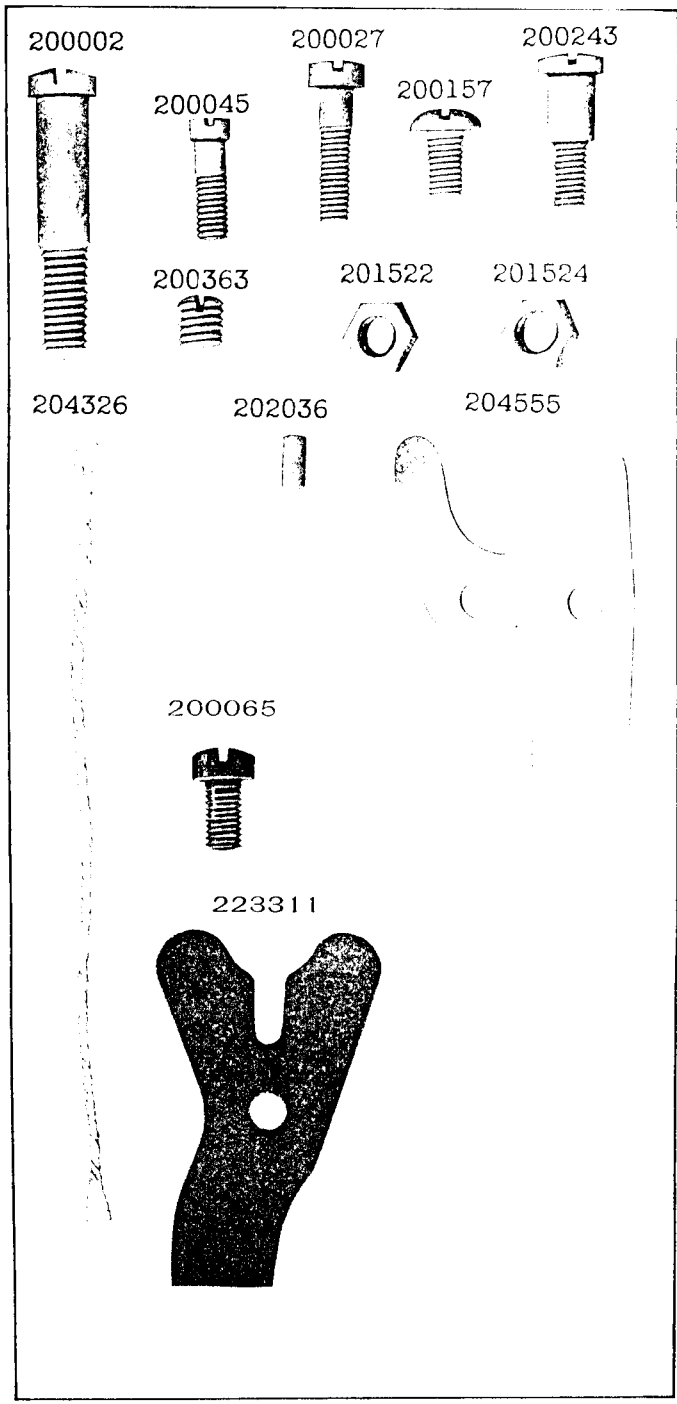
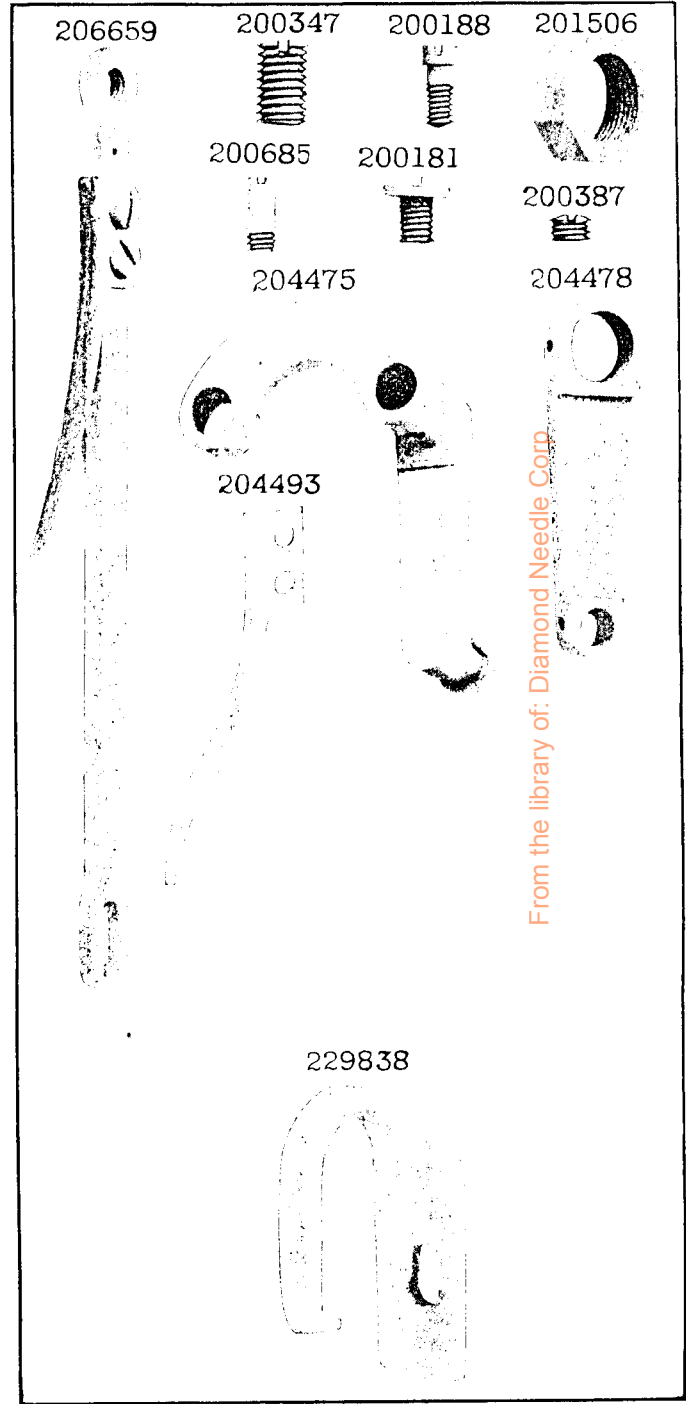


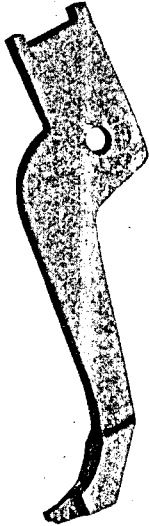
PLATE 12376—FULL SIZE



From the library of: Diamond Needle Corp

PLATE 14066—FULL SIZE

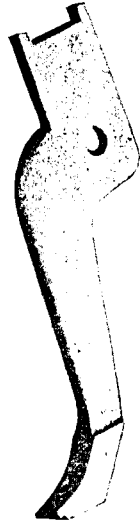
229638



229639



229640



222229  
229641



229642

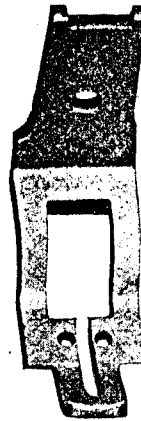


229643



PLATE 14067—FULL SIZE

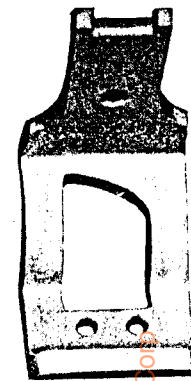
229646



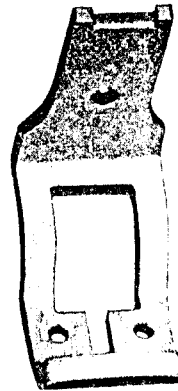
229647



206682  
229648



229650



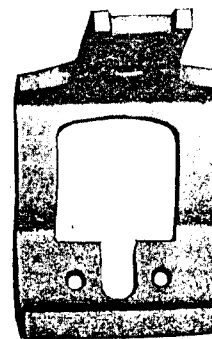
229651



229649



229652



229653



From the library of: Diamond Need Co.

PLATE 14083—ONE-SIXTH SIZE

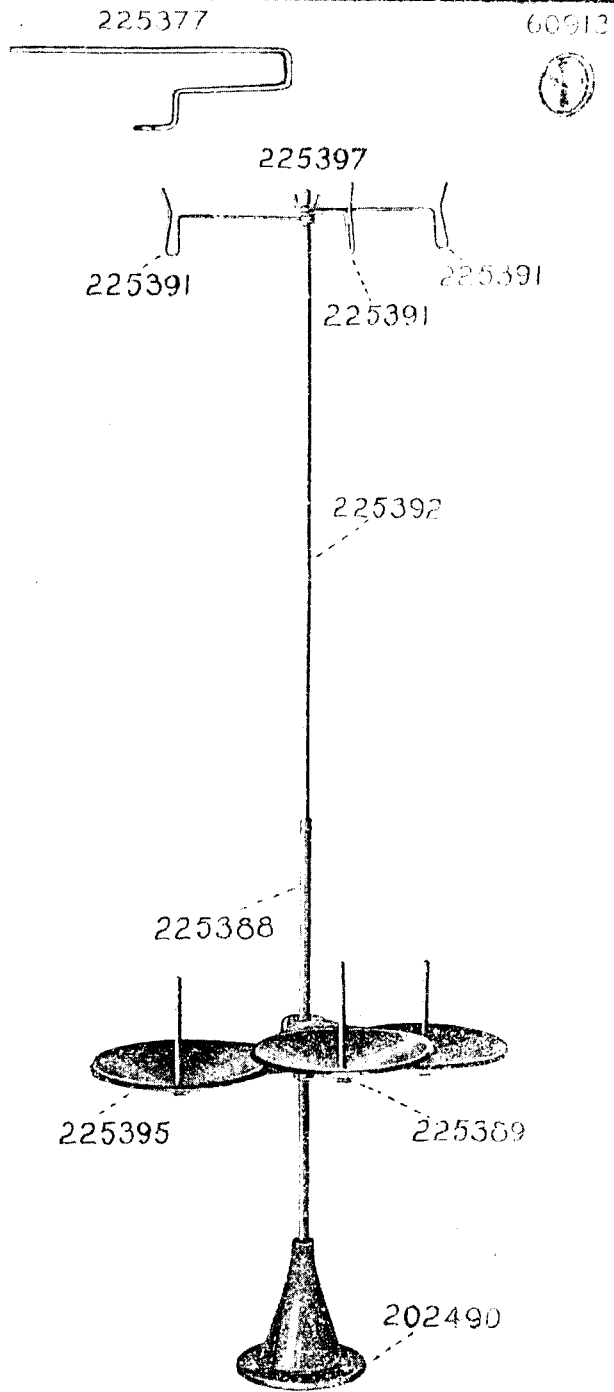
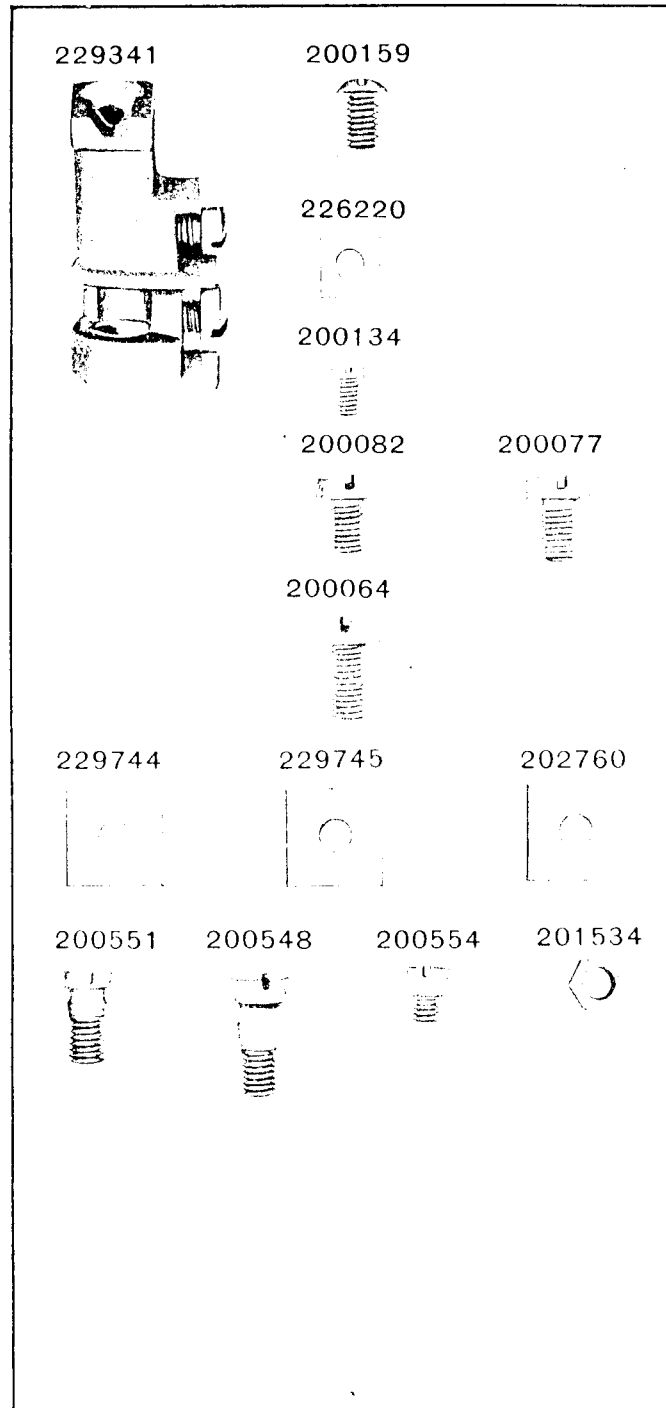


PLATE 14307—FULL SIZE



From the library of: Diamond Needle Corp

PLATE 14308—ONE-HALF SIZE

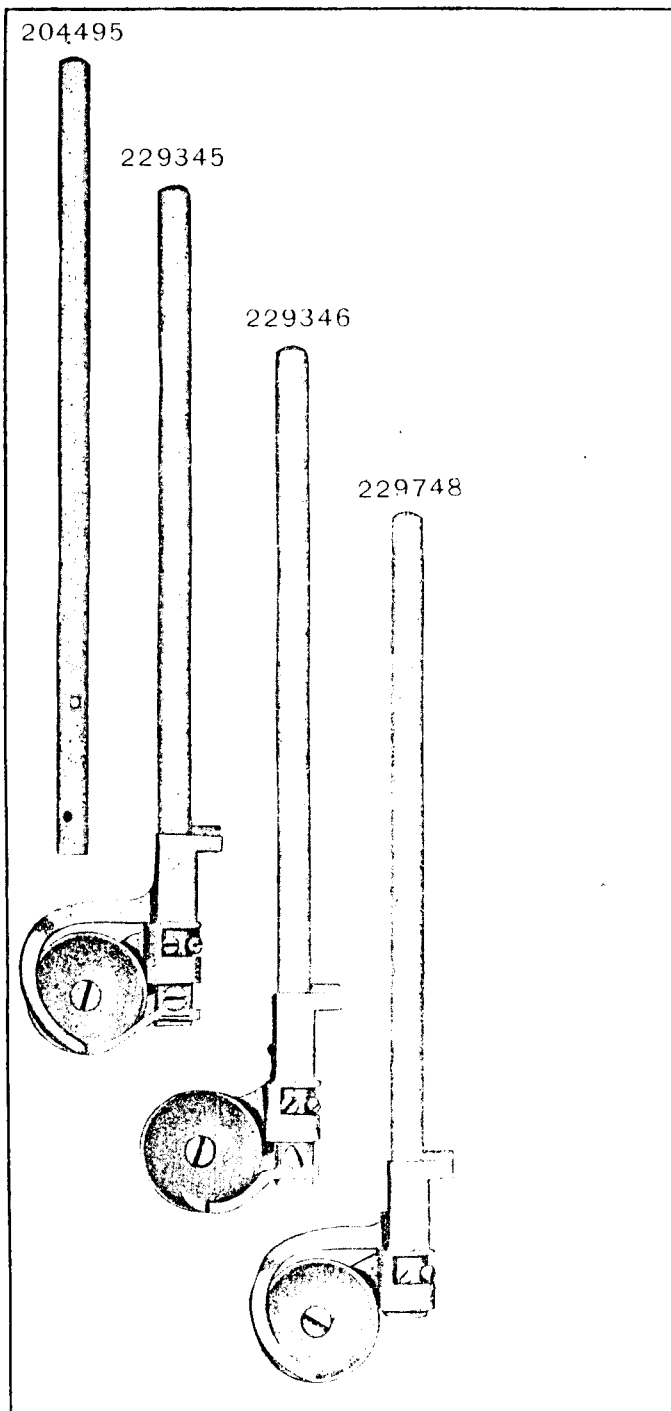


PLATE 14309—FULL SIZE

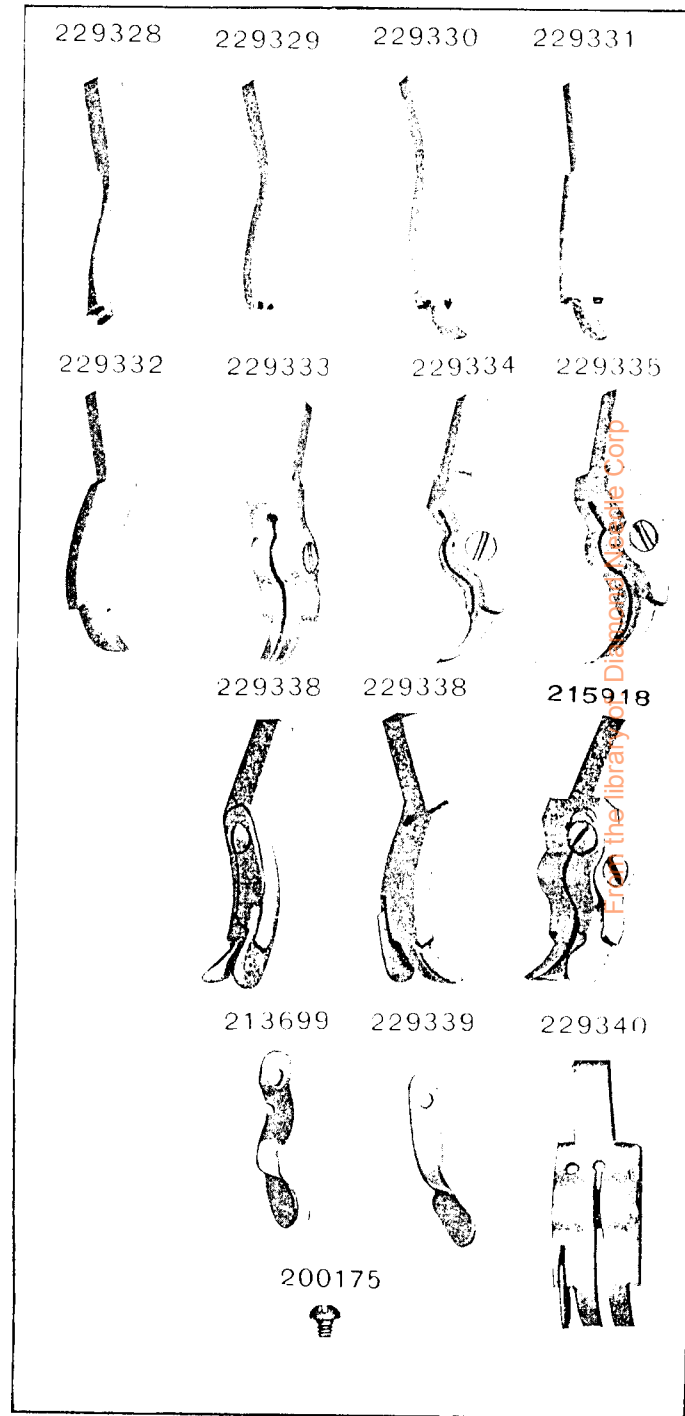


PLATE 14312—ONE-HALF SIZE

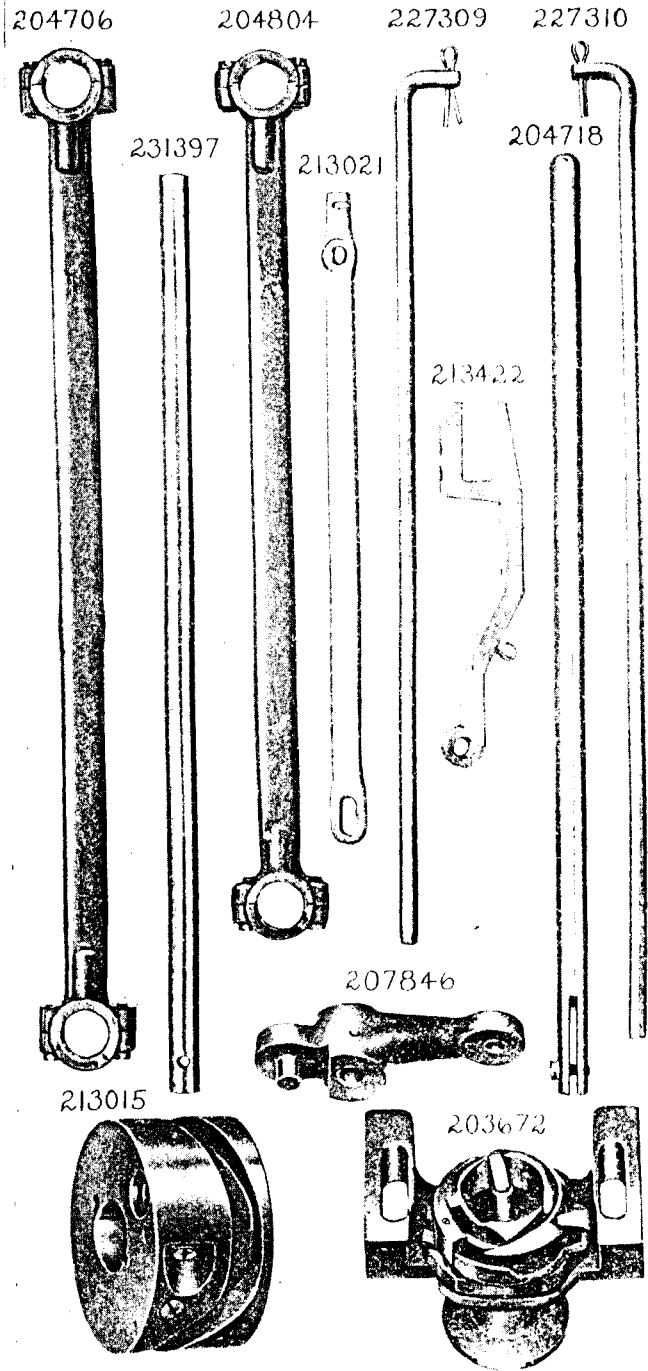
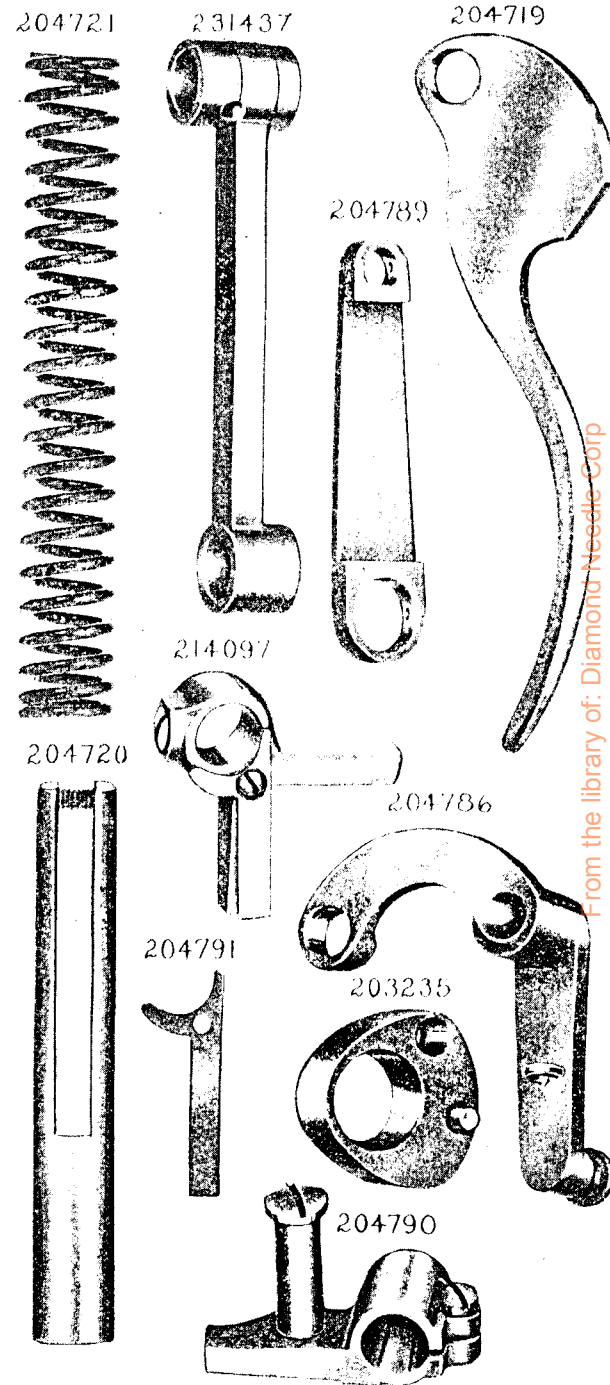


PLATE 14313—FULL SIZE



From the library of: Diamond Needle Corp

PLATE 14314—FULL SIZE

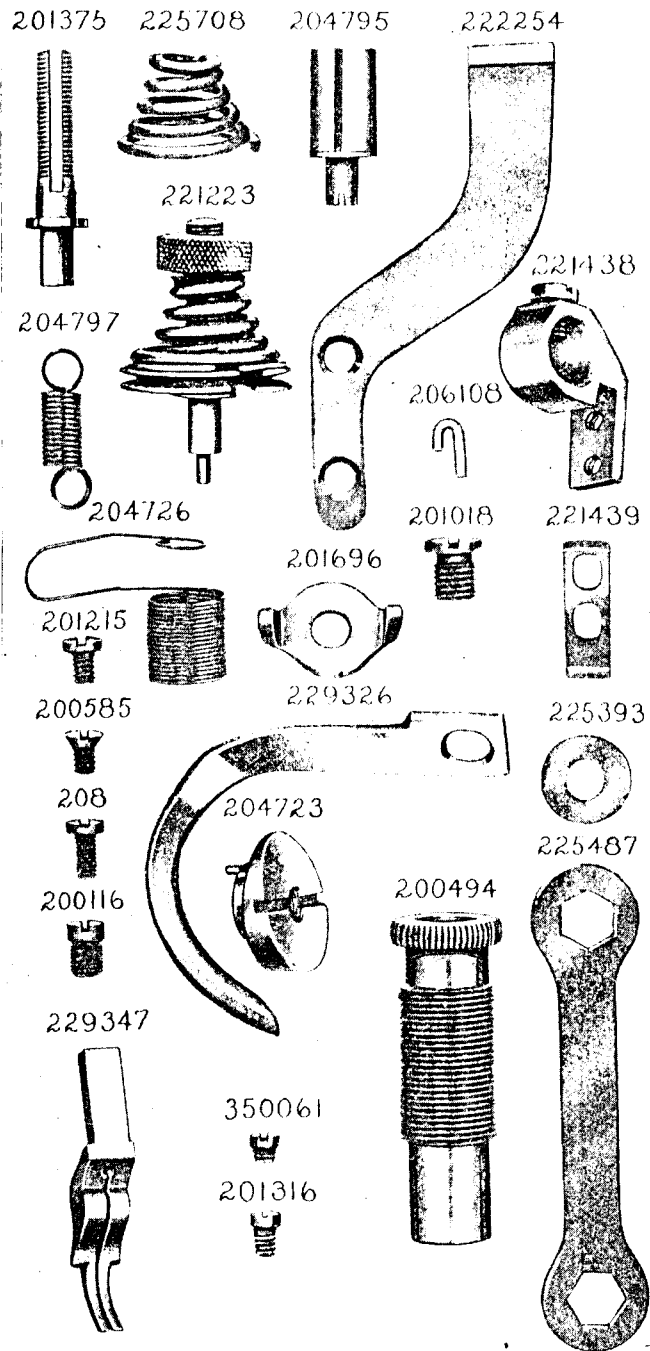
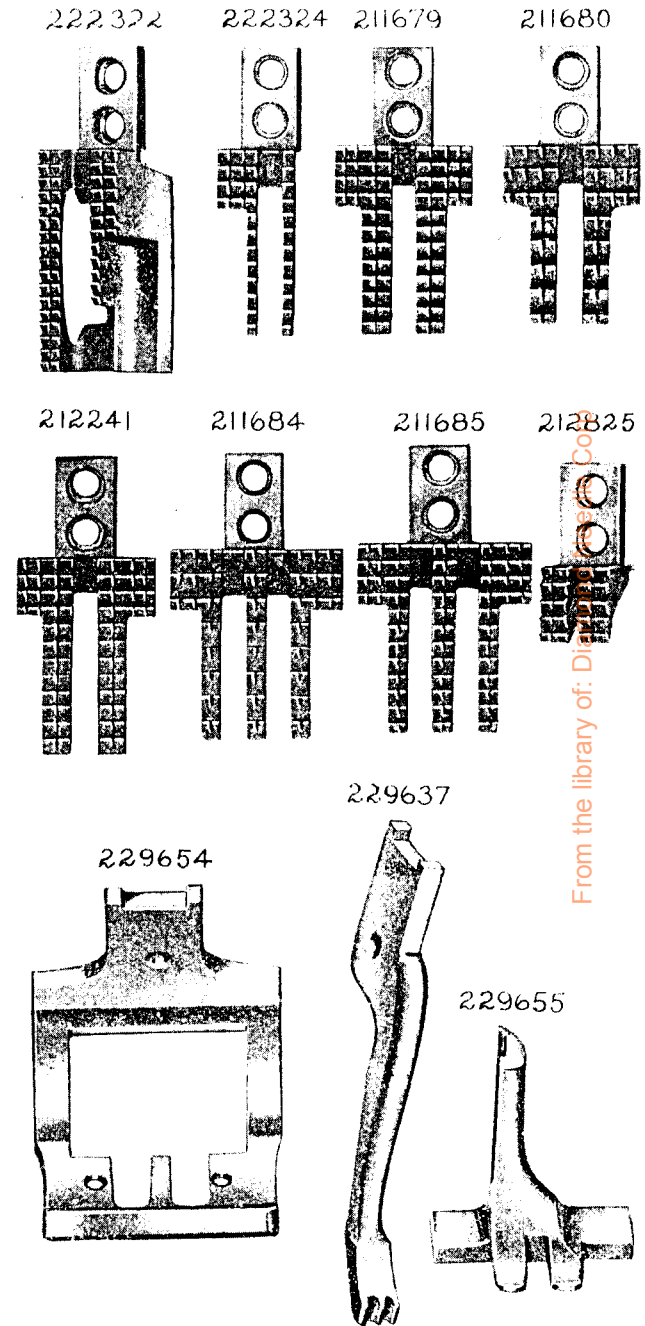


PLATE 14315—FULL SIZE



From the library of: Digital Library of the University of Michigan



PLATE 14316—FULL SIZE

211739



211740



211623



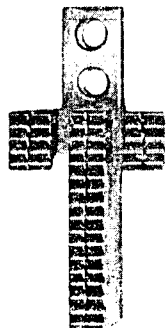
211624



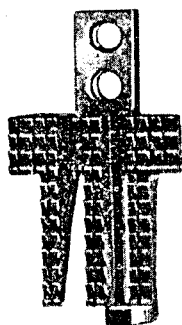
222227



211982



231516



229123



229124



PLATE 14317—FULL SIZE

212103



212104



212571



211630



211298



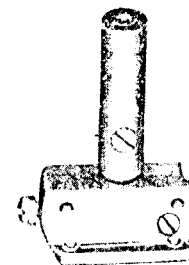
222267



222268



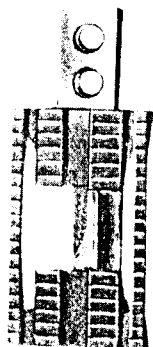
231400



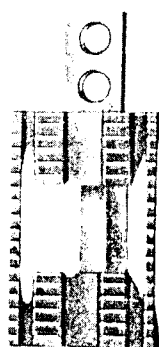
From the Library of Digital Commons

PLATE 14318—FULL SIZE

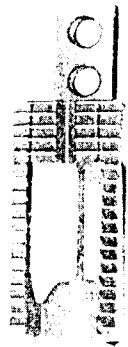
212474



212169



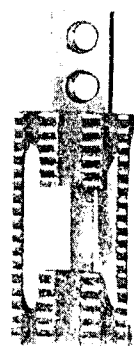
222288



236411



236419



236423



211805

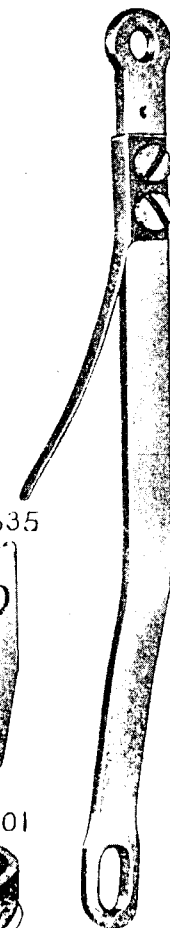


PLATE 14319—FULL SIZE

204492



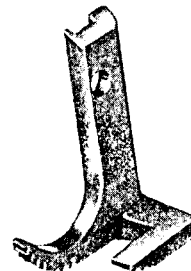
204489



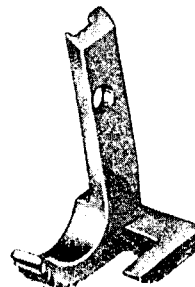
204488



204625



204631



204635



203697



203701



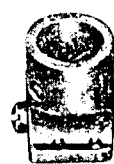
203703



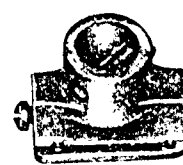
203704



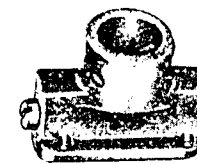
203714



213896



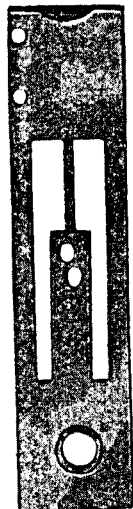
213897



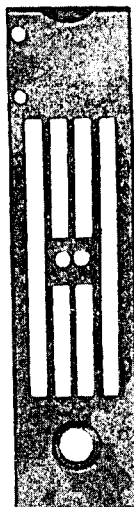
From the library of: Diamond Needs Corp

PLATE 14320—FULL SIZE

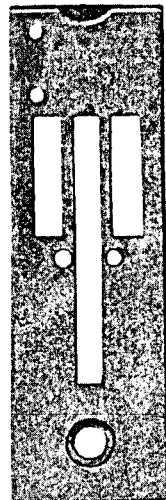
212109  
212110



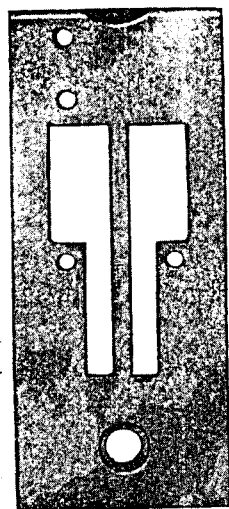
212133  
212134



203777



212271



212272

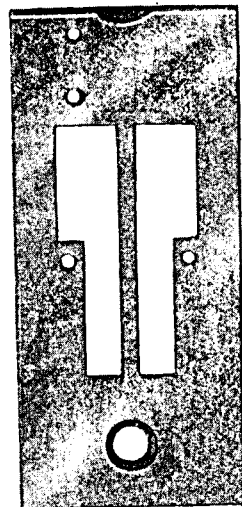
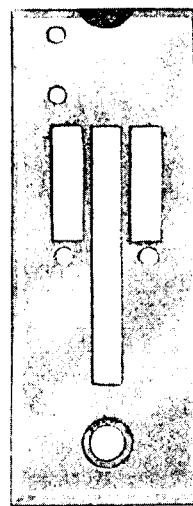
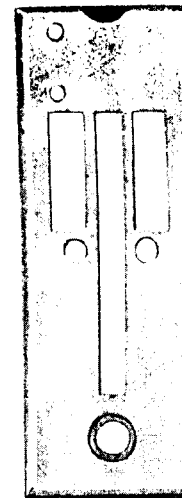


PLATE 14321—FULL SIZE

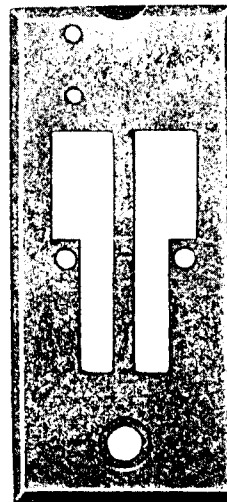
212025  
212026



222240



212240



212242

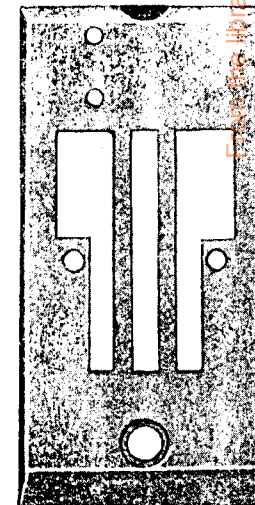
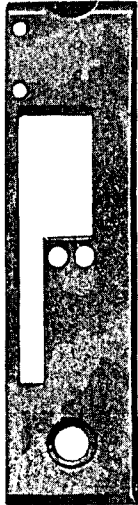
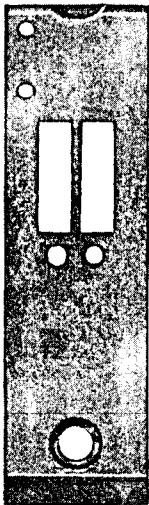


PLATE 14322—FULL SIZE

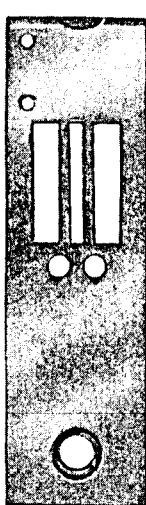
222230



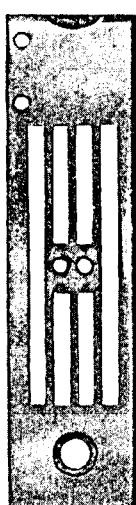
212824



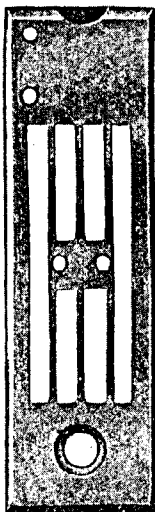
222228



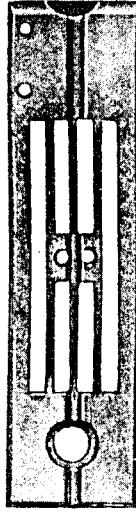
222259



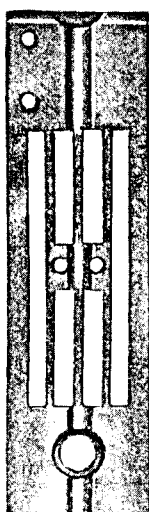
222260



222261



222262



222289  
222290  
222291

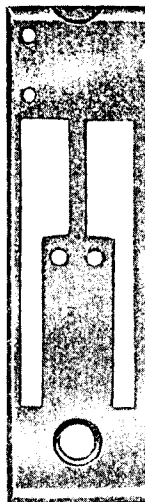
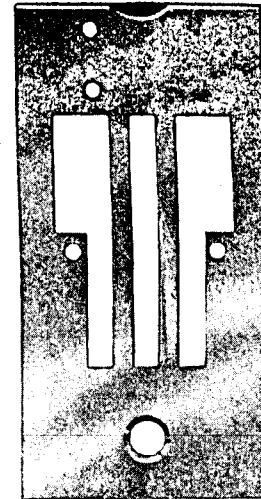


PLATE 14323—FULL SIZE

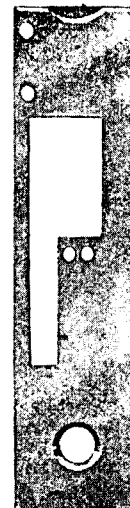
212273



212099  
212111  
212112



212113  
212114



From the library of: *Diamond*

PLATE 14324-ONE-HALF SIZE

213108

213110

203403

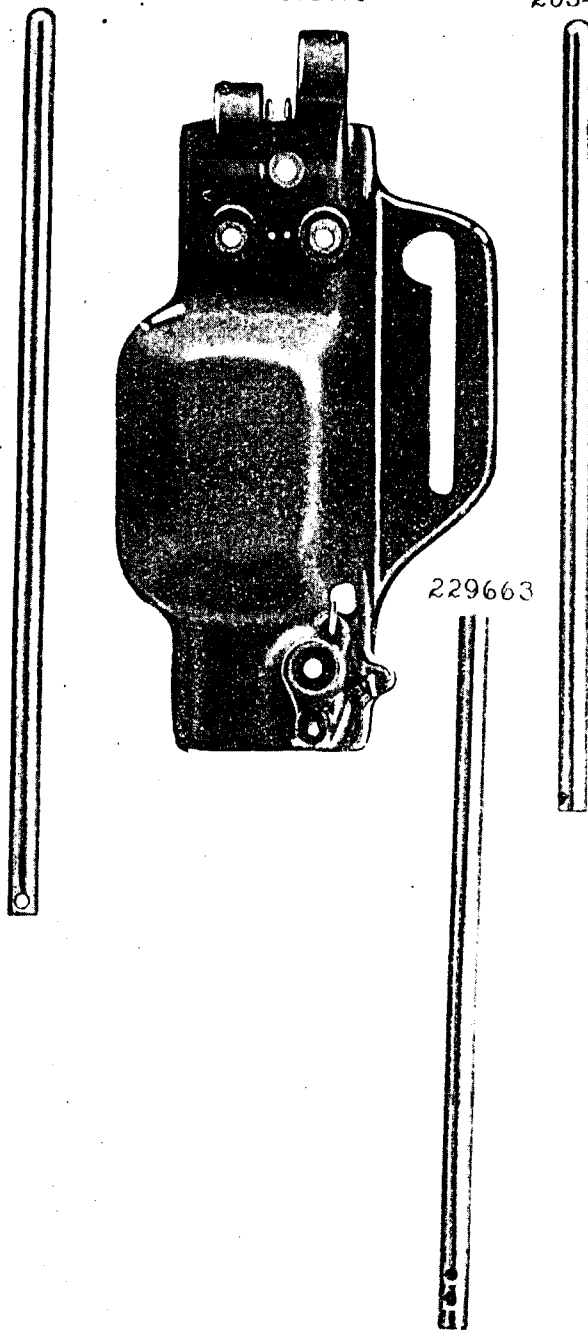


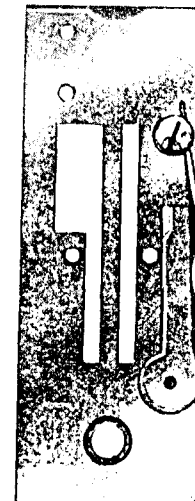
PLATE 14325-FULL SIZE

211952

222323



222325



From the library of: Diamond Mesu

PLATE 14383—ONE-HALF SIZE

225497



225554

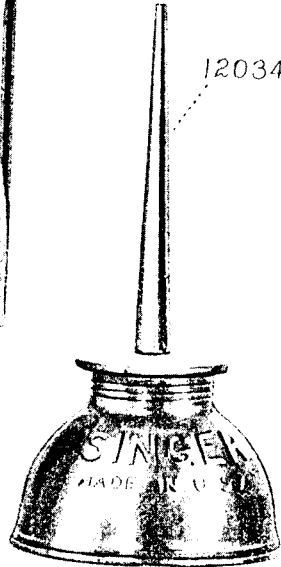


225498



120342

120343



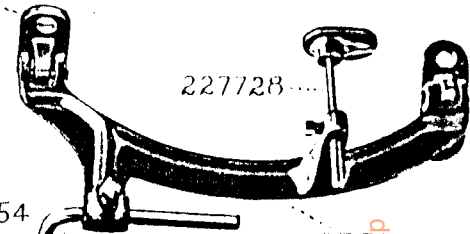
41400



PLATE 14384—ONE-FOURTH SIZE

202451

227787



227728

202454

227781

202453



From the library of: Diamond Needle Corp